

**MF2412C/MF2413C/MF2414C
Microwave Frequency
Counter
Operation Manual**

Sixth Edition

**For safety and warning information, please read this manual before attempting to use the equipment.
Keep this manual with the equipment.**

ANRITSU CORPORATION

Safety Symbols

To prevent the risk of personal injury or loss related to equipment malfunction, Anritsu Corporation uses the following safety symbols to indicate safety-related information. Ensure that you clearly understand the meanings of the symbols BEFORE using the equipment. Some or all of the following symbols may be used on all Anritsu equipment. In addition, there may be other labels attached to products that are not shown in the diagrams in this manual.

Symbols used in manual



DANGER

This indicates a very dangerous procedure that could result in serious injury or death if not performed properly.



WARNING

This indicates a hazardous procedure that could result in serious injury or death if not performed properly.



CAUTION

This indicates a hazardous procedure or danger that could result in light-to-severe injury, or loss related to equipment malfunction, if proper precautions are not taken.

Safety Symbols Used on Equipment and in Manual

The following safety symbols are used inside or on the equipment near operation locations to provide information about safety items and operation precautions. Ensure that you clearly understand the meanings of the symbols and take the necessary precautions BEFORE using the equipment.



This indicates a prohibited operation. The prohibited operation is indicated symbolically in or near the barred circle.



This indicates an obligatory safety precaution. The obligatory operation is indicated symbolically in or near the circle.



This indicates a warning or caution. The contents are indicated symbolically in or near the triangle.



This indicates a note. The contents are described in the box.



These indicate that the marked part should be recycled.

MF2412C/MF2413C/MF2414C
Microwave Frequency Counter
Operation Manual

9 April 2007 (First Edition)
20 November 2013 (Sixth Edition)

Copyright © 2007-2013, ANRITSU CORPORATION.

All rights reserved. No part of this manual may be reproduced without the prior written permission of the publisher.

The contents of this manual may be changed without prior notice.

Printed in Japan

For Safety

WARNING



- ALWAYS refer to the operation manual when working near locations at which the alert mark shown on the left is attached. If the advice in the operation manual is not followed, there is a risk of personal injury or reduced equipment performance. The alert mark shown on the left may also be used with other marks and descriptions to indicate other dangers.

- **Overvoltage Category**

This equipment complies with overvoltage category II defined in IEC 61010. DO NOT connect this equipment to the power supply of overvoltage category III or IV.

Electric Shock

- To ensure that the equipment is grounded, always use the supplied 3-pin power cord, and insert the plug into an outlet with a ground terminal. If power is supplied without grounding the equipment, there is a risk of receiving a severe or fatal electric shock or causing damage to the internal components.

Repair

WARNING 

- Only qualified service personnel with a knowledge of electrical fire and shock hazards should service this equipment. This equipment cannot be repaired by the operator. DO NOT attempt to remove the equipment covers or unit covers or to disassemble internal components. There are high-voltage parts in this equipment presenting a risk of severe injury or fatal electric shock to untrained personnel. In addition, there is a risk of damage to precision components.

Calibration



- The performance-guarantee seal verifies the integrity of the equipment. To ensure the continued integrity of the equipment, only Anritsu service personnel, or service personnel of an Anritsu sales representative, should break this seal to repair or calibrate the equipment. Be careful not to break the seal by opening the equipment or unit covers. If the performance-guarantee seal is broken by you or a third party, the performance of the equipment cannot be guaranteed.

For Safety

WARNING

Falling Over

- This equipment should always be positioned in the correct manner. If the cabinet is turned on its side, etc., it will be unstable and may be damaged if it falls over as a result of receiving a slight mechanical shock.

Always set up the equipment in a position where the power switch can be reached without difficulty.

Replacing Battery



- When replacing the battery, use the specified battery and insert it with the correct polarity. If the wrong battery is used, or if the battery is inserted with reversed polarity, there is a risk of explosion causing severe injury or death.

Battery Fluid

- DO NOT short the battery terminals and never attempt to disassemble the battery or dispose of it in a fire. If the battery is damaged by any of these actions, the battery fluid may leak. This fluid is poisonous. DO NOT touch the battery fluid, ingest it, or get in your eyes. If it is accidentally ingested, spit it out immediately, rinse your mouth with water and seek medical help. If it enters your eyes accidentally, do not rub your eyes, rinse them with clean running water and seek medical help. If the liquid gets on your skin or clothes, wash it off carefully and thoroughly.

Battery Disposal

- DO NOT expose batteries to heat or fire. Do not expose batteries to fire. This is dangerous and can result in explosions or fire. Heating batteries may cause them to leak or explode.
-

For Safety

CAUTION

Fuse Replacement

CAUTION 

- Always remove the mains power cable from the power outlet before replacing blown fuses. There is a risk of electric shock if fuses are replaced with the power cable connected. Replace the fuses with the same type. Failure to do so may result in fire.

T3.15A indicates a time-lag fuse.

Cleaning

- Always remove the main power cable from the power outlet before cleaning dust around the power supply and fan.
 - Clean the power inlet regularly. If dust accumulates around the power pins, there is a risk of fire.
 - Keep the cooling fan clean so that the ventilation holes are not obstructed. If the ventilation is obstructed, the cabinet may overheat and catch fire.

Check Terminal



- Never input a signal of more than the indicated value between the measured terminal and ground. Input of an excessive signal may damage the equipment.

Use in a Residential Environment

This equipment is designed for an industrial environment. In a residential environment, this equipment may cause radio interference in which case the user may be required to take adequate measures.

Use in Corrosive Atmospheres

Exposure to corrosive gases such as hydrogen sulfide, sulfurous acid, and hydrogen chloride will cause faults and failures. Note that some organic solvents release corrosive gases.

Equipment Certificate

Anritsu Corporation certifies that this equipment was tested before shipment using calibrated measuring instruments with direct traceability to public testing organizations recognized by national research laboratories, including the National Institute of Advanced Industrial Science and Technology, and the National Institute of Information and Communications Technology, and was found to meet the published specifications.

Anritsu Warranty

Anritsu Corporation provides the following warranty against stoppages arising due to manufacturing error, and against problems with operation occurring even though the procedures outlines in the operation manual were followed.

Hardware:

Problems occurring within a period of one year from the date of delivery will be corrected by Anritsu Corporation at no cost to the user.

Software:

Software reported as faulty within a period of 6 months from the date of delivery will be corrected or replaced by Anritsu Corporation at no cost to the user.

Following correction or replacement the software will remain under warranty for either the remainder of 6 months from the date of initial delivery, or for a period of 30 days, whichever is shorter.

The hardware and software warranties are not valid under any of the following conditions:

- The fault is outside the scope of the warranty conditions separately described in the operation manual.
- The fault is due to mishandling, misuse, or unauthorized modification or repair of the equipment by the customer.
- The fault is due to severe usage clearly exceeding normal usage.
- The fault is due to improper or insufficient maintenance by the customer.
- The fault is due to natural disaster, including fire, wind, flooding, earthquake, lightning strike, or volcanic ash, etc.
- The fault is due to damage caused by acts of destruction, including civil disturbance, riot, or war, etc.
- The fault is due to explosion, accident, or breakdown of any other machinery, facility, or plant, etc.
- The fault is due to use of non-specified peripheral or applied equipment or parts, or consumables, etc.

- The fault is due to use of a non-specified power supply or in a non-specified installation location.
- The fault is due to use in unusual environments^(Note).
- The fault is due to activities or ingress of living organisms, such as insects, spiders, fungus, pollen, or seeds.

In addition, this warranty is valid only for the original equipment purchaser. It is not transferable if the equipment is resold.

Anritsu Corporation shall assume no liability for injury or financial loss of the customer due to the use of or a failure to be able to use this equipment.

Note:

For the purpose of this Warranty, "unusual environment" means use:

- In places of direct sunlight
- In dusty places
- Outdoors
- In liquids, such as water, oil, or organic solvents, and medical fluids, or places where these liquids may adhere
- In salty air or in place chemically active gases (sulfur dioxide, hydrogen sulfide, chlorine, ammonia, nitrogen dioxide, or hydrogen chloride etc.) are present
- In places where high-intensity static electric charges or electromagnetic fields are present
- In places where abnormal power voltages (high or low) or instantaneous power failures occur
- In places where condensation occurs
- In the presence of lubricating oil mists
- In places at an altitude of more than 2,000 m
- In the presence of frequent vibration or mechanical shock, such as in cars, ships, or airplanes

Anritsu Corporation Contact

In the event of this equipment malfunctions, contact an Anritsu Service and Sales office. Contact information can be found on the last page of the printed version of this manual, and is available in a separate file on the CD version.

Notes On Export Management

This product and its manuals may require an Export License/Approval by the Government of the product's country of origin for re-export from your country.

Before re-exporting the product or manuals, please contact us to confirm whether they are export-controlled items or not.

When you dispose of export-controlled items, the products/manuals need to be broken/shredded so as not to be unlawfully used for military purpose.

Crossed-out Wheeled Bin Symbol

Equipment marked with the Crossed-out Wheeled Bin Symbol complies with council directive 2002/96/EC (the “WEEE Directive”) in European Union.



For Products placed on the EU market after August 13, 2005, please contact your local Anritsu representative at the end of the product's useful life to arrange disposal in accordance with your initial contract and the local law.

CE Conformity Marking

Anritsu affixes the CE Conformity marking on the following product(s) in accordance with the Council Directive 93/68/EEC to indicate that they conform to the EMC and LVD directive of the European Union (EU).

CE marking



1. Product Model

Model: MF2412C/MF2413C/MF2414C
Microwave Frequency Counter

2. Applied Directive

EMC: Directive 2004/108/EC
LVD: Directive 2006/95/EC

3. Applied Standards

- EMC: Emission: EN 61326-1: 2006(Class A)
Immunity: EN 61326-1: 2006(Table2)

	Performance Criteria*
IEC 61000-4-2 (ESD)	B
IEC 61000-4-3 (EMF)	A
IEC 61000-4-4 (Burst)	B
IEC 61000-4-5 (Surge)	B
IEC 61000-4-6 (CRF)	A
IEC 61000-4-11 (V dip/short)	B, C

*: Performance Criteria

- A: During testing, normal performance within the specification limits.
- B: During testing, temporary degradation, or loss of function or performance which is self-recovering.
- C: During testing, temporary degradation, or loss of function or performance which requires operator intervention or system reset occurs.

Harmonic current emissions:

EN 61000-3-2: 2006 +A1:2009 A2:2009

(Class A equipment)

: No limits apply for this equipment with an active input power under 75W.

- LVD: EN 61010-1: 2010 (Pollution Degree 2)

4. Authorized representative

Name: Murray Coleman
Head of Customer Service EMEA
ANRITSU EMEA Ltd.
Address, city: 200 Capability Green, Luton
Bedfordshire, LU1 3LU
Country: United Kingdom

C-tick Conformity Marking

Anritsu affixes the C-tick marking on the following product(s) in accordance with the regulation to indicate that they conform to the EMC framework of Australia/New Zealand.

C-tick marking



1. Product Model

Model: MF2412C/MF2413C/MF2414C
Microwave Frequency Counter

2. Applied Standards

EMC: Emission: EN 61326-1: 2006(Class A equipment)

Power Line Fuse Protection

For safety, Anritsu products have either one or two fuses in the AC power lines as requested by the customer when ordering.

Single fuse: A fuse is inserted in one of the AC power lines.

Double fuse: A fuse is inserted in each of the AC power lines.

Example 1: An example of the single fuse is shown below:

Fuse Holder

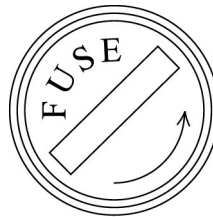

Example 2: An example of the double fuse is shown below:

Fuse Holders

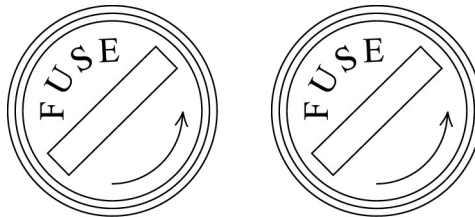

About This Manual

This Operation Manual describes operations and maintenance of the MF2412C/MF2413C/MF2414C Microwave Frequency Counters. Read Section 1 “Overview” for a better understanding of the basic functional operations of this unit. More detailed descriptions are provided in the subsequent sections, being arranged so that the required information can be found easily.

Section 6	Operating Principles	6-1
6.1	Configuration.....	6-2
6.2	Frequency Measurement.....	6-3
6.3	Burst Width Measurement/Burst Period Measurement	6-7
6.4	Trigger Error.....	6-8
Section 7	Performance Test.....	7-1
7.1	When to Run Performance Tests	7-2
7.2	List of Performance Test Equipment	7-3
7.3	Performance Test	7-4
Section 8	Storing and Transporting	8-1
8.1	Cleaning the Cabinet	8-2
8.2	Notes on Storage	8-3
8.3	Repackaging and Transporting.....	8-4
8.4	Final Disposal	8-4
Appendix A	List of Initial Values and Preset Values	A-1
Appendix B	Performance Test Result Sheet.....	B-1
Index		Index-1

Section 1 Overview

This section provides a product overview of the MF2412C/MF2413C/MF2414C Microwave Frequency Counters (hereinafter, referred to as “this unit”) and describes the structure of this operation manual, standard composition, optional products and accessories for expanding functions, standard specifications, and specifications of optional products.

1.1	Product Overview	1-2
1.2	Manual Configuration.....	1-4
1.3	Product Composition	1-5
	1.3.1 Standard composition.....	1-5
	1.3.2 Options	1-5
	1.3.3 Optional accessories	1-6
1.4	Specifications.....	1-7
	1.4.1 Standard specifications	1-7
	1.4.2 Specifications for Option 003	1-15

1.1 Product Overview

This unit is a microwave frequency counter capable of directly measuring frequencies without an external mixer. It also has burst wave carrier frequency measurement and pulse width measurement capabilities, which are indispensable for evaluating circuits and mobile radio communications devices.

This device offers simple operability. A simple one-step operation on the front panel permits switching between continuous wave measurement and burst wave measurement. It is also possible to enter a variety of settings from the front panel directly, including measurement resolution, gate timing for pulse width measurement, and delay time.

The available frequency range and the Input1 input connector type differ depending on the models. Table 1.1-1 lists the available frequency ranges and input connector types for each model.

Table 1.1-1 Models, Available Frequency Ranges, and Input 1 Connector Types

Model	Available Frequency Range (Input1 and Input2)	Input1 Connector Type
MF2412C	10 Hz to 20 GHz	N
MF2413C	10 Hz to 27 GHz	SMA
MF2414C	10 Hz to 40 GHz	K

Features

- Wide band measurement from 10 Hz to 40 GHz (MF2414C)
- High-speed measurement using a fast counter module
- High-accuracy burst measurement
- Graphical display
- Built-in template function*1
- High-speed transient measurement*2
- GPIB standardly equipped

- *1: The template function is used to show whether the measured frequency value is acceptable. The frequency range is specified in advance by the upper and lower limits, and if a measured frequency value falls within the specified range, “Go” is displayed. If not, “No-Go” is displayed. This function also outputs a TTL level high signal or a TTL level low signal from the AUX terminal, according to the measured frequency value.
- *2: The high-speed sampling function is used to measure the input frequency in the minimum sampling period (10 μ sec), without measurement pause time. It is also usable for measuring the VCO activation characteristics.

1.2 Manual Configuration

This operation manual consists of eight sections and two appendices (A and B). Table 1.2-1 shows an overview of these sections and appendices.

Table 1.2-1 Manual Configuration

Sections		Description
Section 1	Overview	Provides a product overview and describes the structure of this operation manual, standard composition, optional products and optional accessories for expanding functions, and specifications.
Section 2	Preparation Before Use	Describes what you must do before using (turning on) this unit.
Section 3	Panel Layout and Operation Overview	Describes the layout, function, and operation method of the keys, connectors, and displays on the front, side, and rear panels.
Section 4	Panel Operation	Describes detailed operation in manual mode.
Section 5	GPIB	Describes the functions, specifications, device messages, and program examples of the standard GPIB interface for controlling the unit remotely.
Section 6	Operating Principles	Describes the measurement principle, frequency measurement accuracy, pulse width measurement accuracy, and trigger error.
Section 7	Performance Test	Describes the measurement instruments, setup, and performance tests required for testing the performance of this unit.
Section 8	Storage and Transportation	Describes the daily care for the unit and how to store, repack, and transport the unit.
Appendix A	List of Initial Value and Preset Values	Describes parameter values that are set automatically when the parameter initial value setting command is executed or either there is no backup data or backup data is damaged when the unit is turned on. Also describes parameter values that are set when the Preset key is pressed.
Appendix B	Performance Test Result Sheet	Provides a sheet to record performance test results.

1.3 Product Composition

This section describes the product composition.

1.3.1 Standard composition

Table 1.3.1-1 shows the standard product composition.

Table 1.3.1-1 Standard Product Composition

Item	Model Name/No.	Product Name	Q'ty	Remarks
Main unit	MF2412C MF2413C MF2414C	Microwave Frequency Counter	1	Select one of these models
Standard accessories		Power cord (2.5 m)	1	
	F0012	Fuse (T3.15A)	2	Not included at present
	W2897AE	Operation Manual	1	

1.3.2 Options

Table 1.3.2-1 shows the options for this unit.

Table 1.3.2-1 Options

Model Name/No.	Product Name	Q'ty	Remarks
MF2412C-003 MF2413C-003 MF2414C-003	Crystal Oscillator	1	Aging rate: $\pm 5 \times 10^{-10}$ /day Select one of these models according to the main unit model used.

1.3.3 Optional accessories

Table 1.3.3-1 shows the optional accessories for this unit.

Table 1.3.3-1 Optional Accessories

Model Name/No	Product Name	Remarks
	–Coaxial adapter–	
K224	Coaxial adapter	K-P•K-J, SMA compatible (DC to 40 GHz, SWR1.2) For MF2414C
34RKNF50	Coaxial adapter	Reinforced K-M•N-F (DC to 20 GHz, SWR1.2) For MF2414C
	–Coaxial cord–	
J0527	Coaxial cord	K-P•K-P (DC to 40 GHz) For MF2414C
J0127A	Coaxial cord (1 m)	BNC-P•RG-58A/U•BNC-P
J0853	Coaxial cord (2 m)	Dual-end N-P (20 GHz) For MF2414C
J0854	Coaxial cord (2 m)	Dual-end APC3.5-P (27 GHz) For MF2413C and MF2414C
	–Others–	
J0007	GPIB connection cable (1 m)	
J0008	GPIB connection cable (2 m)	
B0409	Carrying case	With protection cover
B0598A	Carrying bag	Soft type, with protection cover
B0329L	Protective cover	1/2MW2U
B0390G	Rack mounting	19" type, for single unit
B0411A	Rack mounting	19" type, for 2 parallel units

Notes:

- When connecting or disconnecting the K plug connector for measuring to/from the K connector used on MF2414C Input 1, make sure that the center pin does not rotate. If you will be frequently connecting or disconnecting it, insert a coaxial adapter such as K224 between the connectors so as to prevent the cable from being damaged.
- If there is a risk of this unit becoming electrically overloaded, input the signal via the fuse terminal to prevent the counter's internal circuit from being damaged.

1.4 Specifications

1.4.1 Standard specifications

Table 1.4.1-1 shows the standard specifications of this unit.

Table 1.4.1-1 Standard Specifications

No.	Item	MF2412C	MF2413C	MF2414C
1	Frequency range	10 Hz to 20 GHz	10 Hz to 27 GHz	10 Hz to 40 GHz
1.1	CW measurement			
	Input1	600 MHz to 20 GHz	600 MHz to 27 GHz	600 MHz to 40 GHz
	Input2	10 MHz to 1 GHz (50 Ω), 10 Hz to 10 MHz (1 MΩ)		
1.2	Pulse-modulated wave measurement			
(1)	Carrier frequency			
	Input1	600 MHz to 20 GHz	600 MHz to 27 GHz	600 MHz to 40 GHz
	Input2	Pulse-modulated wave cannot be measured.		
(2)	Pulse width	Pulse Width Narrow: 100 ns to 0.1 s Wide: 1 μs to 0.1 s		
(3)	Pulse repetition	340 ns to 0.1 s (Pulse off time ≥ 240 ns)		
2	External trigger pulse width	≥1 μs		
3	Reference input	1, 2, 5, 10 MHz (≤ 1 ppm)		
4	Reference output	Internal reference signal (10 MHz) or external reference input signal (1, 2, 5, 10 MHz)		
5	Input level range	Input1 (sine wave input): -33 to +10 dBm (<12.4 GHz) -28 to +10 dBm (<20 GHz) -25 to +10 dBm (<27 GHz) {0.741 × f (GHz) - 44.6} to +10 dBm (≤40 GHz) Input2 (sine wave input): 25 mVrms to 10 Vrms (1 MΩ) 25 mVrms to 2 Vrms (50 Ω) External Trigger Input: 1.5 V _{DC} ±(2 to 10) V _{p-p} Reference Input: 1 to 5 V _{p-p} Reference Output: ≥2 V _{p-p} (open terminal)		
6	Input/output impedance (nominal value)	Input1: 50 Ω Input2: 1 MΩ (≤35 pF), 50 Ω External Trigger Input: ≥100 Ω Reference Input: ≥1 kΩ Reference Output: ≤400 Ω		

Table 1.4.1-1 Standard Specifications (Cont'd)

No.	Item	MF2412C	MF2413C	MF2414C
7	Connection	Input1: Input2: External Trigger Input: Reference Input: Reference Output:	AC AC DC AC AC	
8	Input/output connectors			
	Input1	N	SMA	K
	Input2	BNC	←	←
	External Trigger Input	BNC	←	←
	Reference Input	BNC	←	←
	Reference Output	BNC	←	←
9	Gating function			
9.1	Trigger	Int: Detects trigger using measured signal Ext: Detects trigger using External Trigger Input Line: Detects trigger using AC Line		
9.2	Trigger delay	Time from trigger detection to count start: OFF, 20 ns to 0.1 s } <ul style="list-style-type: none"> ≤320 ns: Variable in 20-ns steps 320 ns to 1 μs: Variable in 40-ns steps ≥1 μs: Continuously variable in two significant digits 		
9.3	Gate width	100 ns to 0.1 s (Pulse Width Narrow) 1 μs to 0.1 s (Pulse Width Wide) } <ul style="list-style-type: none"> <1 μs: Variable in 20-ns steps ≥1 μs: Continuously variable in two significant digits 		

Table 1.4.1-1 Standard Specifications (Cont'd)

No.	Item	MF2412C	MF2413C	MF2414C																
10	Pulse modulated wave measurement																			
10.1	Carrier frequency measurement	(Measured in Manual mode)																		
(1)	Maximum resolution	<p>The graph plots Maximum Resolution (Hz) on a logarithmic y-axis (10 m to 1 M) against Gate width (s) on a logarithmic x-axis (10 n to 100 m). The resolution is constant at 1 kHz for gate widths between 100 n and 1 μs, then drops to 100 Hz for 1 μs to 10 μs, to 10 Hz for 10 μs to 100 μs, to 1 Hz for 100 μs to 1 m, and finally to 100 mHz for 1 m to 100 m.</p>																		
(2)	Measurement time	<p>Resolution vs. Measurement time (measurement carrier frequency: 1 GHz)</p> <table border="1"> <thead> <tr> <th>Resolution</th> <th>Measurement Time</th> </tr> </thead> <tbody> <tr> <td>1 Hz</td> <td>200 s</td> </tr> <tr> <td>10 Hz</td> <td>20 s</td> </tr> <tr> <td>100 Hz</td> <td>2 s</td> </tr> <tr> <td>1 kHz</td> <td>200 ms</td> </tr> <tr> <td>10 kHz</td> <td>20 ms</td> </tr> <tr> <td>100 kHz</td> <td>5 ms</td> </tr> <tr> <td>1 MHz</td> <td>5 ms</td> </tr> </tbody> </table> <p>Measurement Time $T_{MS} = \max(T, T_s) \times 1 / (f_R \times T_{GW})^2$ f_R: Resolution T_{GW}: Gate width T_s: Processing time (50 μs) T: Period</p>			Resolution	Measurement Time	1 Hz	200 s	10 Hz	20 s	100 Hz	2 s	1 kHz	200 ms	10 kHz	20 ms	100 kHz	5 ms	1 MHz	5 ms
Resolution	Measurement Time																			
1 Hz	200 s																			
10 Hz	20 s																			
100 Hz	2 s																			
1 kHz	200 ms																			
10 kHz	20 ms																			
100 kHz	5 ms																			
1 MHz	5 ms																			
(3)	Accuracy	<p>The above table shows an example of measurement time when $T_{GW} = 0.1/f_R$ and $T = 2/f_R$.</p> <p>± 2 count \pm Time base accuracy \times Measurement frequency \pm Trigger error \pm Residual error 2 *</p> <p>*: Residual error 2 = Measured frequency (GHz)/2 counts (rms)</p>																		

Table 1.4.1-1 Standard Specifications (Cont'd)

No.	Item	MF2412C	MF2413C	MF2414C
10.2	Modulated-pulse width measurement			
(1)	Resolution	1 ns		
(2)	Accuracy	$\pm 20 \text{ ns} \pm \text{Time base accuracy} \times \text{Measurement pulse width} \pm \text{Trigger error}$		
(3)	Displayed unit	Fixed to μs		
10.3	Pulse cycle measurement			
(1)	Resolution	1 ns		
(2)	Accuracy	$\pm 20 \text{ ns} \pm \text{Time base accuracy} \times \text{Measurement cycle} \pm \text{Trigger error}$		
(3)	Displayed unit	Fixed to μs		

Table 1.4.1-1 Standard Specifications (Cont'd)

No.	Item	MF2412C	MF2413C	MF2414C
11	Frequency (CW) measurement			
11.1	Resolution/ Measurement time	<p>Input1: 1 MHz/1 μs to 0.1 Hz/10 s (normal) 1 MHz/0.18 μs to 0.1 Hz/1.8 s (Fast, typical)</p> <p>Input2: 10 MHz to 1 GHz (50 Ω): 1 MHz/1 μs to 0.1 Hz/10 s 10 Hz to 10 MHz (1 MΩ): 1 MHz to 0.001 MHz</p> <p>See the graph below for the measurement time.</p>		
11.2	Measurement accuracy	<p>Input1</p> <p>Count mode</p> <p>Normal: ± 1 count \pm Time base accuracy \times Measurement frequency \pm Residual error 1 *</p> <p>*: Measured frequency (GHz)/10 counts (rms) Example: 0.5 counts (rms) at 5 GHz measurement</p> <p>Fast: ± 1 count \pm Time base accuracy \times Measurement frequency \pm Trigger error \pm Residual error 2 *</p> <p>*: Measured frequency (GHz)/2 counts (rms) Example: 2.5 counts (rms) at 5 GHz measurement</p> <p>Input2</p> <p>(50 Ω) 10 MHz to 1 GHz: ± 1 count \pm Time base accuracy \times Measurement frequency</p> <p>(1 MΩ) 10 Hz to 10 MHz: ± 1 count \pm Time base accuracy \times Measurement frequency \pm Trigger error</p>		

Table 1.4.1-1 Standard Specifications (Cont'd)

No.	Item	MF2412C	MF2413C	MF2414C										
12	Auto/Manual measurement													
12.1	Auto (CW measurement) (Burst measurement)	FM tolerance: 35 MHz _{p-p} Acquisition time: ≤50 ms FM tolerance: 35 MHz _{p-p} Acquisition time: Measurement carrier frequency: 1 GHz, Level: 0 dBm Acquisition time $T_{ACQ} = T_{ACQ1} + T_{ACQ2}$ T_{ACQ1} : See Table A. $T_{ACQ2} = 4 \times \{(T_P + 200 \mu s) \times K\}$ K: See Table B. T_P : Pulse repetition cycle												
Table A Pulse Repetition Cycle T_P vs. T_{ACQ1}														
<table border="1"> <thead> <tr> <th>Pulse Repetition Cycle T_P</th> <th>T_{ACQ1}</th> </tr> </thead> <tbody> <tr> <td>$1 \mu s \leq T_P \leq 1 \text{ ms}$</td> <td>1.1 s</td> </tr> <tr> <td>$1 \text{ ms} < T_P \leq 10 \text{ ms}$</td> <td>1.6 s</td> </tr> <tr> <td>$10 \text{ ms} < T_P \leq 100 \text{ ms}$</td> <td>6.1 s</td> </tr> </tbody> </table>					Pulse Repetition Cycle T_P	T_{ACQ1}	$1 \mu s \leq T_P \leq 1 \text{ ms}$	1.1 s	$1 \text{ ms} < T_P \leq 10 \text{ ms}$	1.6 s	$10 \text{ ms} < T_P \leq 100 \text{ ms}$	6.1 s		
Pulse Repetition Cycle T_P	T_{ACQ1}													
$1 \mu s \leq T_P \leq 1 \text{ ms}$	1.1 s													
$1 \text{ ms} < T_P \leq 10 \text{ ms}$	1.6 s													
$10 \text{ ms} < T_P \leq 100 \text{ ms}$	6.1 s													
Table B Gate Time T_G vs. K														
<table border="1"> <thead> <tr> <th>Gate Time T_G</th> <th>K</th> </tr> </thead> <tbody> <tr> <td>$1 \mu s \leq T_G \leq 10 \mu s$</td> <td>10000</td> </tr> <tr> <td>$10 \mu s < T_G \leq 100 \mu s$</td> <td>100</td> </tr> <tr> <td>$100 \mu s < T_G \leq 100 \text{ ms}$</td> <td>5</td> </tr> </tbody> </table>					Gate Time T_G	K	$1 \mu s \leq T_G \leq 10 \mu s$	10000	$10 \mu s < T_G \leq 100 \mu s$	100	$100 \mu s < T_G \leq 100 \text{ ms}$	5		
Gate Time T_G	K													
$1 \mu s \leq T_G \leq 10 \mu s$	10000													
$10 \mu s < T_G \leq 100 \mu s$	100													
$100 \mu s < T_G \leq 100 \text{ ms}$	5													
Table C Test Data $T_G = 100 \mu s$, K = 100														
<table border="1"> <thead> <tr> <th>Pulse Repetition Cycle T_P</th> <th>Acquisition Time (Maximum) T_{ACQ}</th> </tr> </thead> <tbody> <tr> <td>200 to 400 μs</td> <td>1340 ms</td> </tr> <tr> <td>400 to 600 μs</td> <td>1420 ms</td> </tr> <tr> <td>600 to 800 μs</td> <td>1500 ms</td> </tr> <tr> <td>800 μs to 1 ms</td> <td>1580 ms</td> </tr> </tbody> </table>					Pulse Repetition Cycle T_P	Acquisition Time (Maximum) T_{ACQ}	200 to 400 μs	1340 ms	400 to 600 μs	1420 ms	600 to 800 μs	1500 ms	800 μs to 1 ms	1580 ms
Pulse Repetition Cycle T_P	Acquisition Time (Maximum) T_{ACQ}													
200 to 400 μs	1340 ms													
400 to 600 μs	1420 ms													
600 to 800 μs	1500 ms													
800 μs to 1 ms	1580 ms													
12.2	Manual (CW measurement)	Input tolerance: ±30 MHz (600 MHz to 1 GHz), ±40 MHz (≥1 GHz) Acquisition time: ≤15 ms												

Table 1.4.1-1 Standard Specifications (Cont'd)

No.	Item	MF2412C	MF2413C	MF2414C																
12.3	Manual (Burst measurement)	Input tolerance: ± 30 MHz (0.6 to 1 GHz, Pulse Width Wide Only) ± 20 MHz (≥ 1 GHz, Pulse Width Narrow) ± 40 MHz (≥ 1 GHz, Pulse Width Wide) Acquisition time: ≤ 15 ms (pulse repetition cycle < 1 ms)																		
13	Sample rate	Auto:	10 ms to 10 s (1-2-5 steps), Hold																	
		Manual:	1 ms to 10 s (1-2-5 steps), Hold																	
14	High-speed sampling																			
14.1	Frequency resolution	Input1 High-Speed Sampling Cycle vs. Frequency Resolution <table border="1" style="margin: 10px auto;"> <thead> <tr> <th>High-Speed Sampling Cycle</th> <th>Frequency Resolution</th> </tr> </thead> <tbody> <tr> <td>10 μs</td> <td>10 kHz</td> </tr> <tr> <td>100 μs</td> <td>1 kHz</td> </tr> <tr> <td>1 ms</td> <td>100 Hz</td> </tr> </tbody> </table> Input2 High-Speed Sampling Cycle vs. Frequency Resolution (Measurement frequency 100 MHz) <table border="1" style="margin: 10px auto;"> <thead> <tr> <th>High-Speed Sampling Cycle</th> <th>Frequency Resolution</th> </tr> </thead> <tbody> <tr> <td>10 μs</td> <td>100 kHz</td> </tr> <tr> <td>100 μs</td> <td>10 kHz</td> </tr> <tr> <td>1 ms</td> <td>1 kHz</td> </tr> </tbody> </table>			High-Speed Sampling Cycle	Frequency Resolution	10 μ s	10 kHz	100 μ s	1 kHz	1 ms	100 Hz	High-Speed Sampling Cycle	Frequency Resolution	10 μ s	100 kHz	100 μ s	10 kHz	1 ms	1 kHz
High-Speed Sampling Cycle	Frequency Resolution																			
10 μ s	10 kHz																			
100 μ s	1 kHz																			
1 ms	100 Hz																			
High-Speed Sampling Cycle	Frequency Resolution																			
10 μ s	100 kHz																			
100 μ s	10 kHz																			
1 ms	1 kHz																			
14.2	Frequency accuracy	± 1 count \pm Time base accuracy \times Measurement frequency \pm Trigger error \pm Residual error 2 * *: Residual error 2 = Measurement frequency (GHz)/2 counts(rms)																		
14.3	Time accuracy	Input1: \pm Time base accuracy \times Measurement time \pm Trigger error ± 800 ns Input2: \pm Time base accuracy \times Measurement time \pm Trigger error ± 64 ns/Measurement frequency																		
14.4	Data count	100 to 2000 (1-2-5 steps)																		
14.5	Sampling cycle	10 μ s to 1 ms (1-2-5 steps)																		
15	Template function																			
15.1	Limit frequency range	0 Hz to 20 GHz	0 Hz to 27 GHz	0 Hz to 40 GHz																
15.2	Setting resolution	1 Hz																		

Table 1.4.1-1 Standard Specifications (Cont'd)

No.	Item	MF2412C	MF2413C	MF2414C																								
16	Allowable spurious range	<p>fc: Signal frequency, fs: Spurious signal frequency $fc - fs \leq 500$ MHz</p> <p>Signal level < -2 dBm</p> <table border="1"> <thead> <tr> <th>Signal Frequency</th> <th>Allowable spurious range</th> </tr> </thead> <tbody> <tr> <td>$600 \text{ MHz} \leq fc \leq 40 \text{ GHz}$</td> <td>$\leq -27$ dBc</td> </tr> </tbody> </table> <p>Signal level ≥ -2 dBm</p> <table border="1"> <thead> <tr> <th>Signal Frequency</th> <th>Allowable spurious range</th> </tr> </thead> <tbody> <tr> <td>$600 \text{ MHz} \leq fc \leq 40 \text{ GHz}$</td> <td>$\leq -35$ dBc</td> </tr> </tbody> </table> <p>$fc - fs > 500$ MHz</p> <p>Signal level < -2 dBm</p> <table border="1"> <thead> <tr> <th>Signal Frequency</th> <th>Allowable spurious range</th> </tr> </thead> <tbody> <tr> <td>$600 \text{ MHz} \leq fc \leq 20 \text{ GHz}$</td> <td>$\leq -27$ dBc</td> </tr> <tr> <td>$20 \text{ GHz} < fc \leq 27 \text{ GHz}$</td> <td>$\leq -32$ dBc</td> </tr> <tr> <td>$27 \text{ GHz} < fc \leq 40 \text{ GHz}$</td> <td>$\leq -\{0.741 \times fc \text{ (GHz)} + 12\}$ dBc</td> </tr> </tbody> </table> <p>Signal level ≥ -2 dBm</p> <table border="1"> <thead> <tr> <th>Signal Frequency</th> <th>Allowable spurious range</th> </tr> </thead> <tbody> <tr> <td>$600 \text{ MHz} \leq fc \leq 20 \text{ GHz}$</td> <td>$\leq -35$ dBc</td> </tr> <tr> <td>$20 \text{ GHz} < fc \leq 27 \text{ GHz}$</td> <td>$\leq -40$ dBc</td> </tr> <tr> <td>$27 \text{ GHz} < fc \leq 40 \text{ GHz}$</td> <td>$\leq -\{0.741 \times fc \text{ (GHz)} + 20\}$ dBc</td> </tr> </tbody> </table>			Signal Frequency	Allowable spurious range	$600 \text{ MHz} \leq fc \leq 40 \text{ GHz}$	≤ -27 dBc	Signal Frequency	Allowable spurious range	$600 \text{ MHz} \leq fc \leq 40 \text{ GHz}$	≤ -35 dBc	Signal Frequency	Allowable spurious range	$600 \text{ MHz} \leq fc \leq 20 \text{ GHz}$	≤ -27 dBc	$20 \text{ GHz} < fc \leq 27 \text{ GHz}$	≤ -32 dBc	$27 \text{ GHz} < fc \leq 40 \text{ GHz}$	$\leq -\{0.741 \times fc \text{ (GHz)} + 12\}$ dBc	Signal Frequency	Allowable spurious range	$600 \text{ MHz} \leq fc \leq 20 \text{ GHz}$	≤ -35 dBc	$20 \text{ GHz} < fc \leq 27 \text{ GHz}$	≤ -40 dBc	$27 \text{ GHz} < fc \leq 40 \text{ GHz}$	$\leq -\{0.741 \times fc \text{ (GHz)} + 20\}$ dBc
Signal Frequency	Allowable spurious range																											
$600 \text{ MHz} \leq fc \leq 40 \text{ GHz}$	≤ -27 dBc																											
Signal Frequency	Allowable spurious range																											
$600 \text{ MHz} \leq fc \leq 40 \text{ GHz}$	≤ -35 dBc																											
Signal Frequency	Allowable spurious range																											
$600 \text{ MHz} \leq fc \leq 20 \text{ GHz}$	≤ -27 dBc																											
$20 \text{ GHz} < fc \leq 27 \text{ GHz}$	≤ -32 dBc																											
$27 \text{ GHz} < fc \leq 40 \text{ GHz}$	$\leq -\{0.741 \times fc \text{ (GHz)} + 12\}$ dBc																											
Signal Frequency	Allowable spurious range																											
$600 \text{ MHz} \leq fc \leq 20 \text{ GHz}$	≤ -35 dBc																											
$20 \text{ GHz} < fc \leq 27 \text{ GHz}$	≤ -40 dBc																											
$27 \text{ GHz} < fc \leq 40 \text{ GHz}$	$\leq -\{0.741 \times fc \text{ (GHz)} + 20\}$ dBc																											
17	Display																											
17.1	Display digits	12 digits and one digit for minus sign																										
17.2	Display type	Fluorescent display, 256 × 64 dots																										
18	Backup	The settings at power off are stored into backup memory.																										
19	Reference oscillator stability	<p>Activation characteristics: $\pm 5 \times 10^{-8}$/10 minutes</p> <p>Aging rate: $\pm 5 \times 10^{-9}$/Day, $\pm 8 \times 10^{-8}$/year (after 24 hours from power-on)</p> <p>Temperature characteristics: $\pm 5 \times 10^{-8}$ (0 to 50°C, at 25°C as a reference)</p> <p>Frequency: 10 MHz</p>																										
20	External control	<p>GPIB (conforms to IEEE488.2)</p> <p>Interface function: SH1, AH1, T6, L4, SR1, RL1, PP0, DC1, DT1, C0, E2</p>																										
21	Power supply	<p>100 to 120 V, 200 to 240 V* (auto switching), 50 to 60 Hz</p> <p>During startup: ≤ 90 VA, Under normal operation : ≤ 80 VA</p>																										
22	Temperature range	0 to 50°C																										
23	Dimensions/Mass	88 (H) × 213 (W) × 350 (D) mm, ≤ 5 kg																										

*: Operating voltage: within the range of +10% to -15% from the rated voltage

1.4.2 Specifications for Option 003

Table 1.4.2-1 Specifications for Option 003

Item		MF2412C-003, MF2413C-003, MF2414C-003	
Frequency		10 MHz	
Frequency stability	Aging rate	/day	$\pm 5 \times 10^{-10}$
		/year	$\pm 2 \times 10^{-8}$
		Condition	After 72 hours from power-on
	Temperature		$\pm 5 \times 10^{-9}$
		-10 to +60°C (at 25°C as a reference)	

Section 2 Preparation Before Use

This section describes the preparations and safety measures to be performed before using this unit. The safety measures in this operation manual refer to those required for avoiding the risk of injury and damage to measuring instruments, including this unit. The safety measures are divided into two types: measures to be performed through preparation, and measures the user should know before using this unit.

2.1	Environmental Conditions of Installation Site	2-2
2.2	Safety Measures	2-4
2.2.1	Measures related to power	2-4
2.2.2	Voltage overload on Input1 connector.....	2-5
2.2.3	Voltage overload on Input2 connector.....	2-6
2.2.4	Voltage overload on Reference 1, 2, 5, 10 MHz Input connector	2-7
2.2.5	Voltage overload on External Trigger Input connector.....	2-8
2.3	Power Connection	2-9
2.3.1	Power requirements	2-9
2.3.2	Connecting the power cord	2-9
2.3.3	Changing fuses.....	2-11

2.1 Environmental Conditions of Installation Site

This unit normally operates in the temperature range from 0 to 50°C. Avoid using it under any of the following environment conditions which may cause failure.

- In places of direct sunlight
- In dusty places
- Outdoors
- In liquids, such as water, oil, or organic solvents, and medical fluids, or places where these liquids may adhere
- In salty air or in place chemically active gases (sulfur dioxide, hydrogen sulfide, chlorine, ammonia, nitrogen dioxide, or hydrogen chloride etc.) are present
- In places where high-intensity static electric charges or electromagnetic fields are present
- In places where abnormal power voltages (high or low) or instantaneous power failures occur
- In places where condensation occurs
- In the presence of lubricating oil mists
- In places at an altitude of more than 2,000 m
- In the presence of frequent vibration or mechanical shock, such as in cars, ships, or airplanes

CAUTION

Dew may form inside of this unit if it is moved to a warm location after operating for a long time in a cool location. In such a case, be sure to wait until the unit becomes completely dry before turning on the power switch. Doing so with condensation present may cause a short circuit and damage the unit.

2.1 Environmental Conditions of Installation Site

Distance from fan :

A cooling fan is provided at the rear of this unit to prevent the internal temperature from rising. Install this unit at least 10 cm away from walls, peripheral devices, or the like to prevent blockage of ventilation (see Figure 2.1-1).

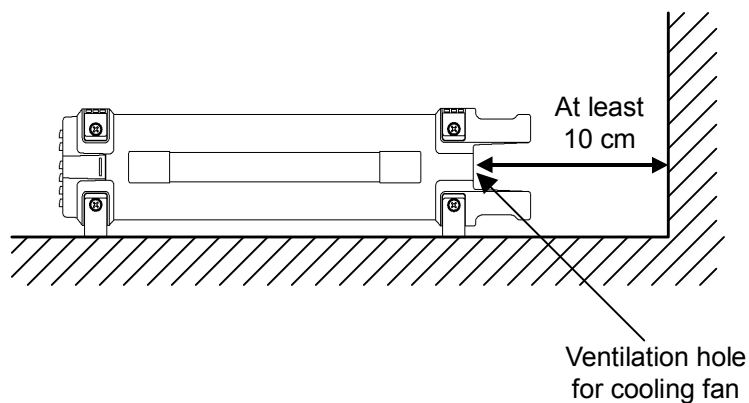
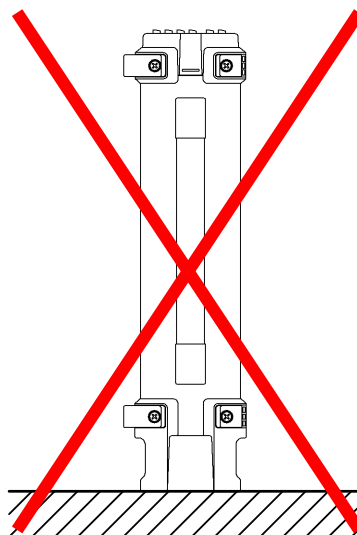

Figure 2.1-1 Unit Placement

CAUTION

Since this unit is equipped with an internal high-accuracy oscillator, it must be installed horizontally to secure high-accuracy measurement.



Do not use the unit if it is placed with its side or rear down, or it is tilted.

If the unit is not installed horizontally, a small shock may turn it over and harm the user.

2.2 Safety Measures

This section describes the safety measures to be taken to prevent electric shock and damage to the unit.

2.2.1 Measures related to power

 **WARNING**

Earth this unit before turning on power. Failing to do so may lead to electric shock causing injury or even death.

Also perform a voltage check. Applying an abnormal voltage exceeding the specifications may damage the unit and cause fire.

Have only service personnel with proper training perform maintenance on this unit.

2.2.2 Voltage overload on Input1 connector

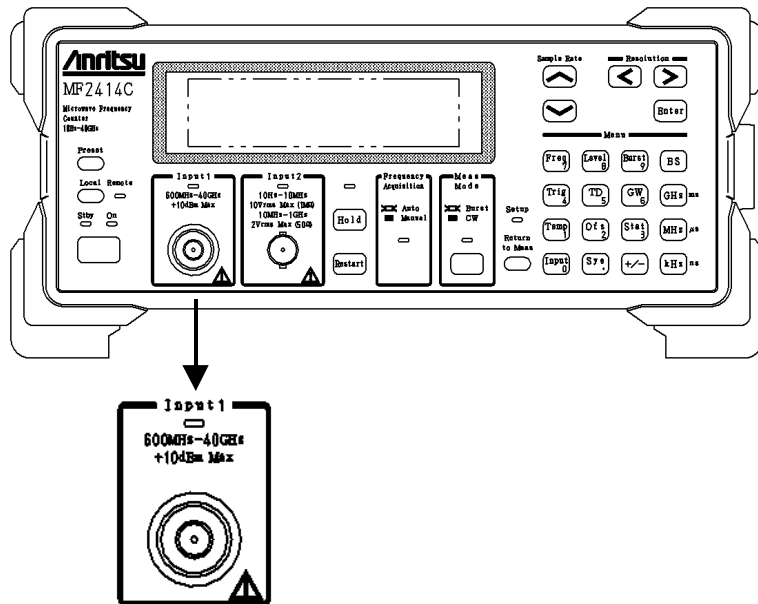

Figure 2.2.2-1 Input1 Connector

CAUTION

- The Input1 connector does not have an overvoltage protection circuit for protecting circuits from voltage overloads. The maximum value of the input signal is +10 dBm. Do not input voltage higher than this value. Failing to obey this warning may cause the internal circuits to burn out.
- Be sure to input a sine wave signal to the Input1 connector.
Anritsu will not guarantee the measurement results when a rectangular or pulse wave is input.
- Internal local (Comb oscillation) leakage from the Input1 connector may have influence on measurement results of other instruments.
Local leakage (typical): About -35 dBm
If the effect from the local leakage cannot be ignored, take measures for the system design, such as providing isolation for the input part of the Input1 connector.

2.2.3 Voltage overload on Input2 connector

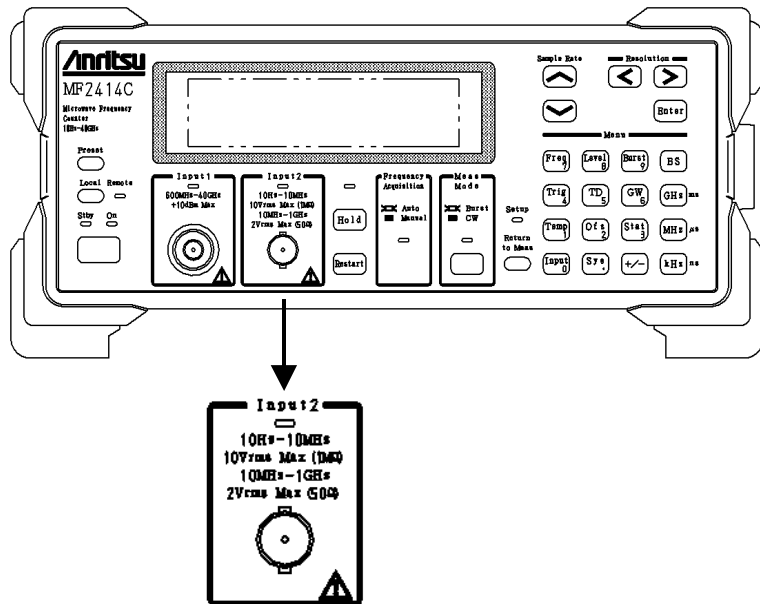

Figure 2.2.3-1 Input2 Connector

CAUTION

- The Input2 connector has an overvoltage protection circuit for protecting circuits from voltage overloads. The maximum value is 10 Vrms when impedance 1 MΩ is selected, and is 2 Vrms when impedance 50 Ω is selected. Do not input voltage higher than this value. Failing to obey this warning may cause the internal circuits to burn out.
- Be sure to input a sine wave signal to the Input2 connector.
Anritsu will not guarantee the measurement results when a rectangular or pulse wave is input.

2.2.4 Voltage overload on Reference 1, 2, 5, 10 MHz Input connector

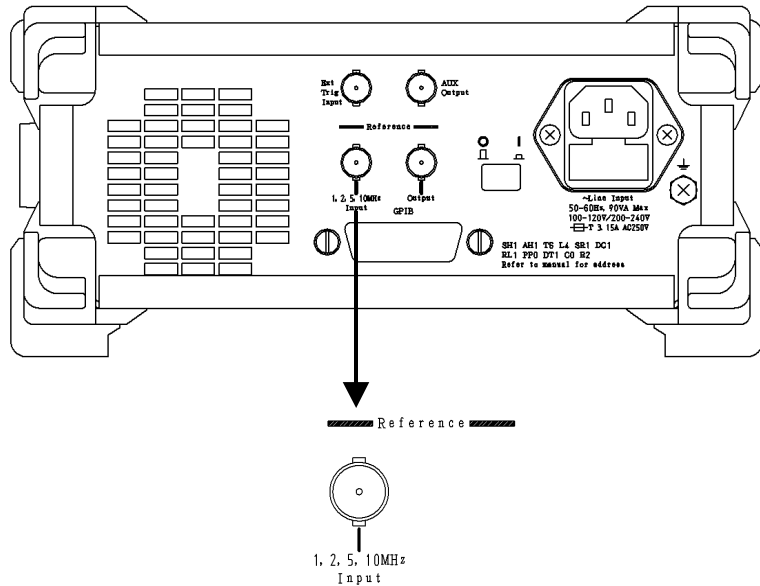

Figure 2.2.4-1 Reference 1, 2, 5, 10 MHz Input Connector

CAUTION

The input level for the Reference 1, 2, 5, 10 MHz Input connector is 1 to 5 Vp-p.

Applying a voltage exceeding 7 Vp-p may cause the internal circuits to burn out.

2.2.5 Voltage overload on External Trigger Input connector

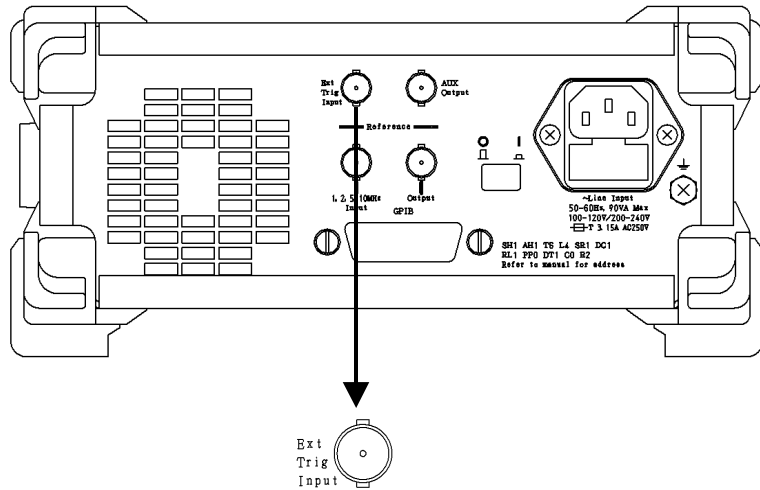

Figure 2.2.5-1 External Trigger Input Connector

 **CAUTION**

The External Trigger Input connector has an overvoltage protection circuit for protecting circuits from voltage overloads. The maximum value is 10 Vp-p. Do not input voltage higher than this value. Failing to obey this warning may cause the internal circuits to burn out.

2.3 Power Connection

2.3.1 Power requirements

For normal operation of this unit, observe the power voltage range described below.

Power Source	Voltage Range	Frequency
100 Vac system	100 to 120 V	50 to 60 Hz
200 Vac system	200 to 240 V	50 to 60 Hz

Changeover between 100 and 200 V systems is made automatically.

 **CAUTION**

Supplying power exceeding the above range may result in electrical shock, fire, failure, or malfunction.

WARNING and CAUTION labels are affixed to the unit as safety precautions to attract the attention of users.

2.3.2 Connecting the power cord

Check that the main power switch on the rear panel is turned off (switched to the (O) side).

Insert the power plug into an outlet, and connect the other end to the power inlet on the rear panel. To ensure that the instrument is earthed, always use the supplied 3-pin power cord, and insert the plug into an outlet with an earth terminal.

 **WARNING**

Always connect the instrument to a properly grounded outlet. Do not use the instrument with an extension cord or transformer that does not have a ground wire.

If the instrument is connected to an ungrounded outlet, there is a risk of receiving a fatal electric shock. In addition, the peripheral devices connected to the instrument may be damaged.

Unless otherwise specified, the signal-connector ground terminal, like an external conductor of the coaxial connector, of the instrument is properly grounded when connecting the power cord to a grounded outlet. Connect the ground terminal of DUT to a ground having the same potential before connecting with the instrument. Failure to do so may result in an electric shock, fire, failure, or malfunction.

 **CAUTION**

If an emergency arises causing the instrument to fail or malfunction, disconnect the instrument from the power supply by either turning off the main power switch on the rear panel (switch to the (O) side), or by pulling out the power cord or the power inlet.

When installing the instrument, place the instrument so that an operator may easily operate the main power switch.

If the instrument is mounted in a rack, a power switch for the rack or a circuit breaker may be used for power disconnection.

It should be noted that, the power switch on the front panel of the instrument is a standby switch, and cannot be used to cut the main power.

2.3.3 Changing fuses

This unit comes with two fuses. Use them when the fuse in the unit burns out.

If the fuse burns out due a problem with the unit, make sure to fix the problem before replacing the fuse.

Rated Voltage	Fuse Rating Indication	Fuse Rating	Fuse Name	Model Name/No.
100 V	T3.15 A	3.15 A, 250 V	T3.15A250V	F0012
230 V	T3.15 A	3.15 A, 250 V	T3.15A250V	F0012

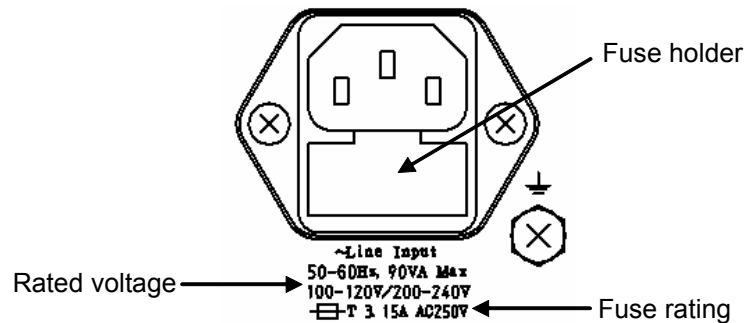

WARNING

- Make sure to switch off power and unplug the power cord from the power outlet before attempting to replace the fuse. Failing to obey this warning may result in electric shock.
- Before turning on the power again after replacing the fuse, make sure that the unit is earthed as described above and the appropriate AC power supply is used. Failing to earth the unit may result in electric shock. Using the wrong AC power supply may damage the unit.

⚠ CAUTION

If you run out of spare fuses, obtain new ones that have the same type and same ratings as the ones that originally came with the unit.

- If you do not use the same type and same ratings of fuse, you may experience problems such as not being able to install it, problems connecting it, or delays in blowout.
- If you use a fuse with a voltage rating that is too high, it may not blow out the next time there is a problem, putting the unit at risk of catching on fire.

After taking the safety measures described above, replace the fuse, following the procedure below.

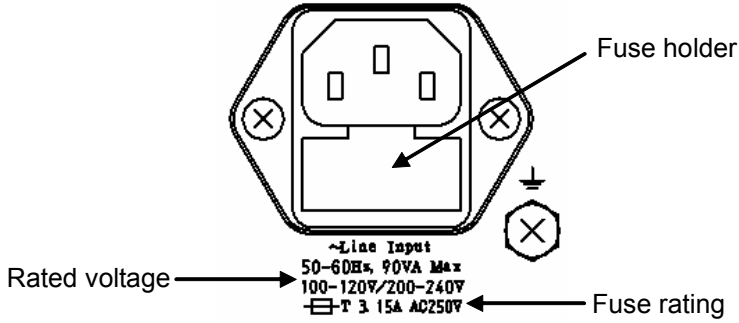
Step	Fuse Replacement Procedure
1	Turn off the power line switch on the rear panel. Confirm that the LCD on the front panel and all LEDs go out at this time.
2	Open the fuse holder shown below. <div style="text-align: center; margin: 10px 0;">  </div>
3	Remove the fuse from the fuse holder, and insert a new fuse*.
4	Return the fuse holder to its original position.

*: Replacement fuses may be ordered from our service department when necessary. Provide us with the model name, number, part name, and quantity you need.

Section 3 Panel Layout and Operation Overview

This section describes the layouts and functions of the keys, switches, LEDs, connectors, and displays on the front, and rear panels of this unit. This section also provides an overview of how to operate these controls. For more information on operating the unit, refer to Section 4 “Panel Operation.”

3.1	Panel Layout.....	3-2
3.1.1	Front panel layout.....	3-2
3.1.2	Rear panel layout	3-7
3.2	Operation Overview	3-9
3.2.1	Operation overview.....	3-9
3.2.2	Parameter setup hierarchy	3-10
3.2.3	Functions of each key.....	3-13

3.1 Panel Layout

This section describes the keys, switches, LEDs, connectors, and displays on the front and rear panels.

3.1.1 Front panel layout

Figure 3.1.1-1 shows the layout of the front panel, followed by Table 3.1.1-1, which provides functional descriptions of each component.

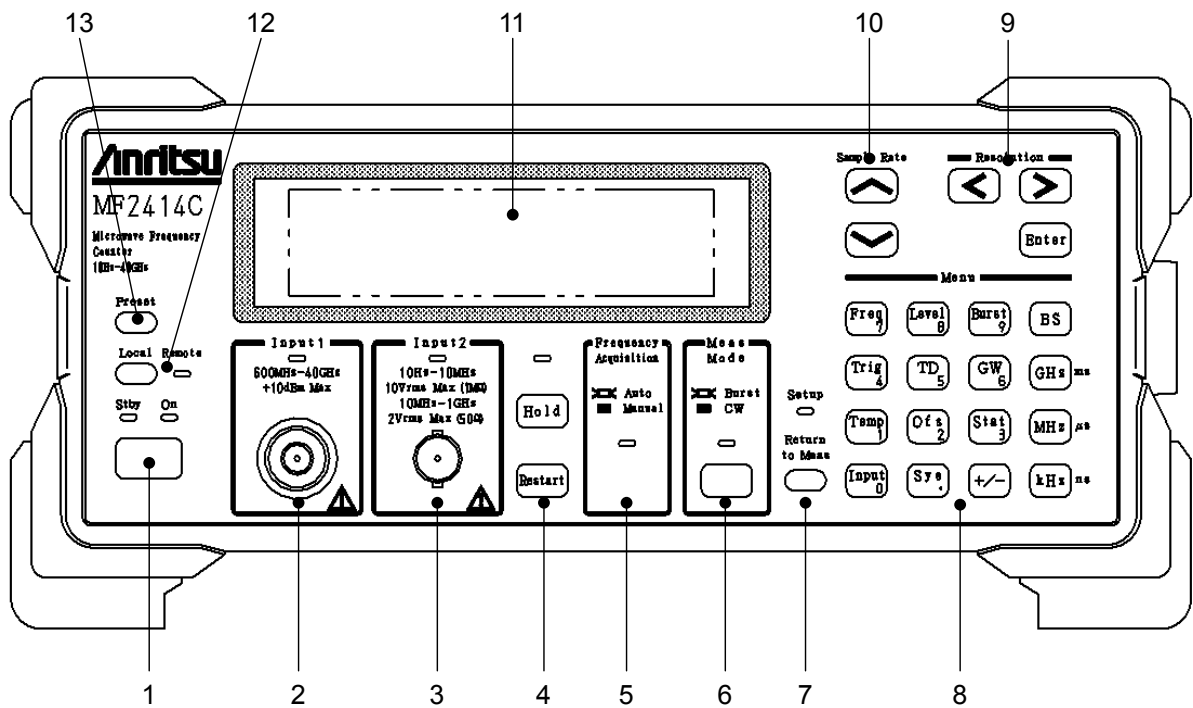

Figure 3.1.1-1 Front Panel Layout

Table 3.1.1-1 Function of Components on Front Panel





No.	Label	Description
1		<p>Power switch, Stby LED and On LED</p> <p>When the Power Line switch on the rear panel is turned from Off to On, this unit enters the standby state, in which power is supplied only to the internal crystal oscillator. The Stby LED lights up orange during the standby state.</p> <p>When the unit is in the standby state, pressing the Power switch turns on the unit and supplies power to all circuits, allowing you to use the unit. The On LED lights up green when the unit becomes ready.</p> <p>If the Power switch is pressed when the unit is on, the unit enters the standby state.</p>
2		<p>Input1 input connector and Input1 LED</p> <p>Connect the signal to this connector when measuring frequencies of 600 MHz or higher, particularly frequencies of 1 GHz or higher.</p> <p>The available frequency range and the connector type differ depending on models. See Table 1.1-1 for details.</p> <p>The Input1 LED lights up when the Input1 connector becomes usable. To use the Input1 connector, select "Input1" from the Input CH menu on the Input parameter setup screen.</p>
3		<p>Input2 input connector and Input2 LED</p> <p>Connect the signal to this connector when measuring frequencies from 10 Hz to 1 GHz.</p> <p>The Input2 LED lights up when the Input2 connector becomes usable. To use the Input2 connector, select "Input2" from the Input CH menu on the Input parameter setup screen.</p>
4		<p>Hold key, Restart key, and Hold LED</p> <p>While frequency measurement is being performed repeatedly, pressing the Hold key stops measurement and keeps the current value display. This state is referred to as a hold state. While the unit is in the hold state, pressing the Hold key restores the repetition measurement.</p> <p>The Hold LED lights up when the unit enters the hold state.</p> <p>Pressing the Restart key restarts a measurement or statistical process. While the unit is in the hold state, pressing the Restart key performs a measurement or statistical process only once and places the unit in the hold state again. This operation is referred to as single measurement.</p>

Table 3.1.1-1 Function of Components on Front Panel (Cont'd)







No.	Label	Description
5	 <p>The image shows a screen titled 'Frequency Acquisition'. It has two options: 'Auto' with a checked radio button and 'Manual' with an unchecked radio button. Below the options is a small horizontal bar.</p>	<p>Frequency Acquisition LED</p> <p>This LED indicates whether the frequency of the signal input to the Input1 connector is to be acquired automatically (Auto) or manually (Manual).</p> <p>When “Auto” is selected, the unit measures the input signals across the entire measurement frequency bands and then measures only the signal frequencies that have reached the prescribed level.</p> <p>When “Manual” is selected and a signal within the prescribed frequency input tolerance is input, the unit measures the frequency of that signal.</p> <p>The Frequency Acquisition LED lights up when “Auto” is selected as the frequency acquisition mode. To select automatic frequency acquisition, select “Auto” from the Mode menu on the Freq Acq parameter setup screen.</p>
6	 <p>The image shows a screen titled 'Meas Mode'. It has two options: 'Burst' with a checked radio button and 'CW' with an unchecked radio button. Below the options is a small horizontal bar and a larger rounded rectangular button.</p>	<p>Meas Mode key and Meas Mode LED</p> <p>The Meas Mode key is used to determine whether to measure burst waves (Burst) or continuous waves (CW).</p> <p>When burst wave measurement is selected, the unit can measure the carrier frequency, burst signal width, and burst repetition period.</p> <p>When continuous wave measurement is selected, the unit measures that frequency.</p> <p>The Meas Mode LED lights up when burst wave measurement is selected.</p>
7	 <p>The image shows a screen with two options: 'Setup' with a small horizontal bar and 'Return to Meas' with a larger rounded rectangular button.</p>	<p>Return to Meas key and Setup LED</p> <p>To return to the measurement screen from a parameter setup screen, press the Return to Meas key.</p> <p>The Setup LED lights up when the parameter setup screen is selected (displayed).</p>

Table 3.1.1-1 Function of Components on Front Panel (Cont'd)

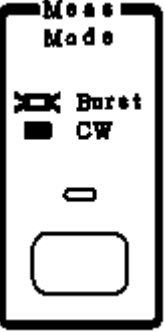
No.	Label	Description
8		<p>Numeric keys and direct keys</p> <p>In the numeric input mode, numeric values from 0 to 9 and a dot (printed on the lower right of each key) can be entered by pressing the corresponding keys. Also, the +/-, GHz, MHz, kHz, and BS keys are used to enter numeric values, and they are collectively referred to as “numeric keys.”</p> <p>In modes other than the numeric input mode, the above keys are used to display the parameter setup screens corresponding to the items printed above the panel. These keys are collectively referred to as “direct keys.”</p> <p>Freq: Used to display the Freq Acq parameter setup screen. Level: Used to display the Level Acq parameter setup screen. Burst: Used to display the Burst parameter setup screen. Trig: Used to display the Trigger parameter setup screen. TD: Used to display the Trigger Delay parameter setup screen. GW: Used to display the Gate Width parameter setup screen. Temp: Used to display the Template parameter setup screen. Ofs: Used to display the Offset parameter setup screen. Stat: Used to display the Statistic parameter setup screen. Input: Used to display the Input parameter setup screen. Sys: Used to display the System parameter setup screen.</p> <p>Pressing any of the direct keys displays the corresponding parameter setup screen and turns on the Setup LED.</p>
9		<p>←, →, and Enter key</p> <p>When a measurement screen is displayed, pressing the ← or → key changes the frequency measurement resolution.</p> <p>When a parameter setup screen is displayed, pressing the ← or → key moves the cursor.</p> <p>The Enter key is used to toggle between two parameters, select one of three or more parameters, or turn on/off the input mode of the numeric input menu.</p>
10		<p>▲ and ▼ keys</p> <p>When a measurement screen is displayed, pressing the ▲ or ▼ key changes the measurement pause time (Sample Rate).</p> <p>When the Level Acq parameter setup screen is displayed, pressing the ▲ or ▼ key changes the manual amplitude discrimination value.</p> <p>When the Trig Delay or Gate Width parameter setup screen is displayed, pressing the ▲ or ▼ key increments or decrements the numeric parameter value.</p>
11		<p>256 × 64 dot LCD</p> <p>This display is used to display frequency measurement results and set various parameters.</p>

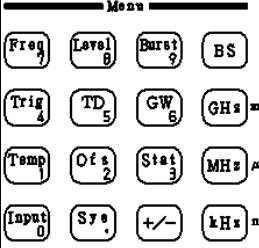
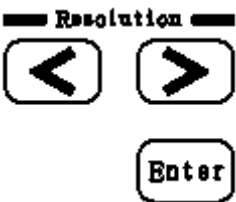
Section 3 Panel Layout and Operation Overview

Table 3.1.1-1 Function of Components on Front Panel (Cont'd)

No.	Label	Description
12	<p>Local Remote</p> 	<p>Local key and Remote LED</p> <p>Pressing the Local key changes the state of this unit from the remote control state to the local control state. The Remote LED lights up when the unit is in the remote state.</p>
13	<p>Preset</p> 	<p>Preset key</p> <p>Pressing the Preset key restores all the parameters to the default values. For details on parameter setting values, refer to Appendix A “List of Initial Value and Preset Values.”</p>

3.1.2 Rear panel layout

Figure 3.1.2-1 shows the layout of the rear panel, followed by Table 3.1.2-1 that provides the functional description of each component.

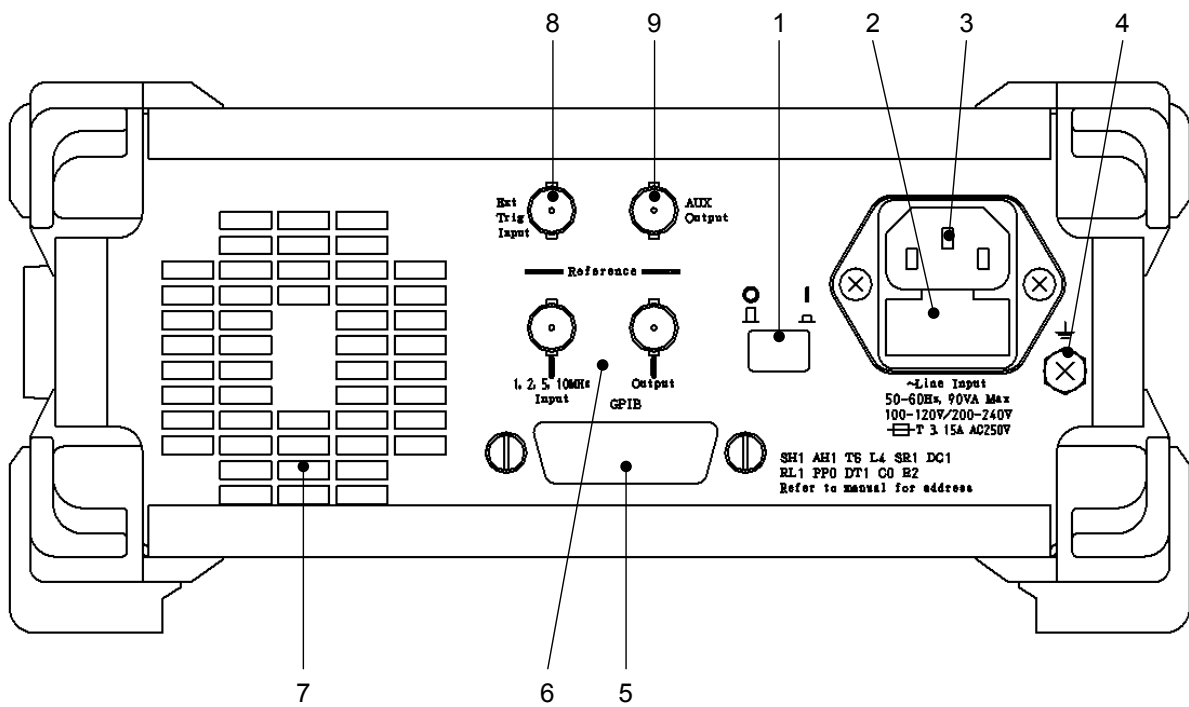
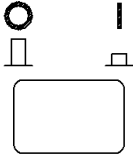
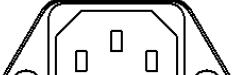

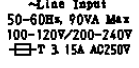

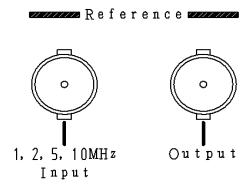
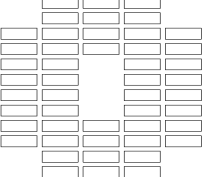
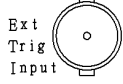



Figure 3.1.2-1 Rear Panel Layout

Table 3.1.2-1 Function of Components on Rear Panel

No.	Label	Description
1		<p>Power line switch</p> <p>Switch for supplying power to the unit. Power is supplied to the crystal oscillator when this switch is switched from the Off to the On position (pressed down). At this time, if the power button on the front panel is turned on, power is supplied to the components on this unit.</p>
2		<p>Fuse holder</p> <p>A fuse is contained. When replacing the fuse, make sure to use one of the same type and rating (T3.15A), to avoid bodily harm or damage to the unit.</p>
3		<p>AC power inlet</p> <p>Connect the power cord. Make sure to use only a cord properly rated for this unit to avoid bodily harm or damage to the unit.</p>
4		<p>Functional earth terminal</p> <p>This is the terminal that is electrically connected to the chassis of the equipment.</p>
5		<p>GPIB interface connector</p> <p>Connect a GPIB cable to this connector and connect the other end to the host computer when controlling the unit from a host computer. Make sure to turn off the unit and host computer before connecting the cable.</p>
6		<p>Reference signal input connector and reference signal output connector</p> <p>When operating the unit using an external reference signal, input the signal to the reference signal input connector. The unit supports four frequencies: 1, 2, 5, and 10 MHz.</p> <p>The reference signal used by the unit is output from the reference signal output connector.</p>
7		<p>Cooling fan</p> <p>Provided to let out hot air from inside the unit. The fan must be at least 10 cm away from any surrounding obstacles.</p>
8		<p>External trigger input connector</p> <p>Provided to input an external trigger signal for performing frequency measurement in synchronization with external equipment. This connector is active when the external trigger (Ext Trig) is enabled.</p>
9		<p>AUX output connector</p> <p>Provided to output a signal from a unit component. The signal to be output is selected according to the parameter setting.</p>

3.2 Operation Overview

3.2.1 Operation overview

This unit has two major states: measurement state and parameter setup state. Also, two screen display types are provided, in accordance with these states.

When the unit is turned on, the start screen showing the self-check results is displayed for several seconds, and the measurement screen is then displayed.

The measurement screen and the parameter setup screen can be switched by pressing a direct key or the **Return to Meas** key, as shown in Figure 3.2.1-1. Pressing a direct key changes the screen from the measurement screen to the corresponding parameter setup screen, and pressing the **Return to Meas** key changes from a parameter setup screen to the measurement screen.

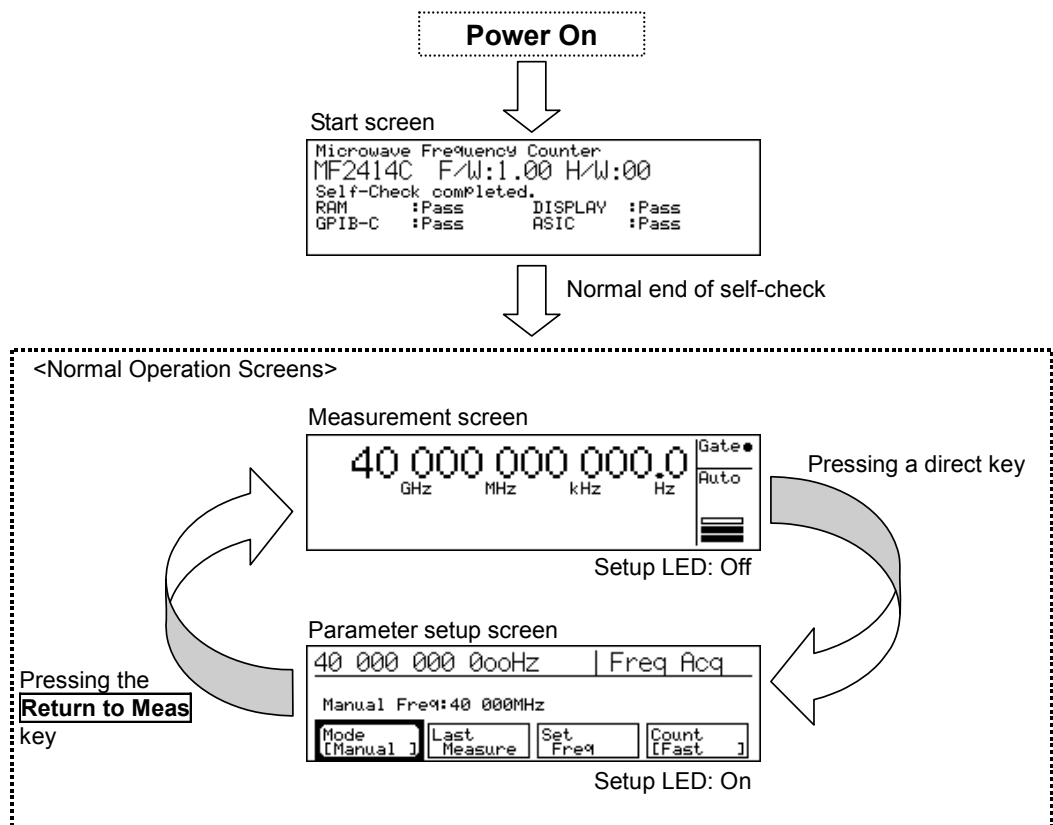

Figure 3.2.1-1 Screen Transition

3.2.2 Parameter setup hierarchy

Pressing a direct key to set parameters displays the corresponding parameter setup screen. In the setup screen, the parameters listed in Level 1 column of Table 3.2.2-1 can be set.

If a parameter that cannot be set from Level 1 is selected, the Level 2 parameters are displayed on the setup screen, enabling you to set various parameters. See Table 3.2.2-1 for the hierarchical structure of each parameter setup screen.

Table 3.2.2-1 Hierarchical Structure of Parameter Setup Screens

Conventions

- Mode** (frame): Indicates a key.
- [Mode] (brackets): Indicates a displayed menu item.
- Auto/Manual (slash): Indicates exclusive selection.



Direct Key	Level 1	Level 2
Measurement mode Meas Mode CW/Burst	–	–
Frequency acquisition*1 Freq	Mode [Mode] Auto/Manual	–
	Measurement result assignment [Last Meas]	–
	Frequency value input [Set Freq]	–
	Counting method [Count] Fast/Normal	–
Level acquisition*1 Level	Mode [Mode] Auto/Manual	–
	Auto setup value assignment [Last Meas]	–
	Level up [∧]	–
	Level down [∨]	–
Burst*1 Burst	Burst measurement mode [Mode] Freq/Width/Period	–
	Burst measurement polarity [Polarity] Pos/Neg  (Pos)/  (Neg)	–
	Burst width [Width] Wide/Narrow	–

Table 3.2.2-1 Hierarchical Structure of Parameter Setup Screens (Cont'd)

Direct Key	Level 1	Level 2
Trigger & gate End Trig	Trigger mode [Mode] Int/Ext/Line	— —
	Trigger polarity [Slope] Rise/Fall  (Rise)/ (Fall)	—
	Gate End [Gate End] On/Off	—
Trigger delay TD	Burst monitor screen [Trig Delay]	—
Gate width GW	Burst monitor screen [Gate Width]	—
Template Temp	Template [Template] On/Off	—
	Upper frequency limit [Upper Limit]	—
	Lower frequency limit [Lower Limit]	—
	Movement direction indicator [Indicate] On/Off	—
Offset Ofs	Offset mode [Mode] Off/+Offset/-Offset/ppm	—
	Measurement value assignment [Last Meas]	—
	Offset frequency input [Set Freq]	—
	Update mode [Update] On/Off	—
Statistic processing Stat	Statistic processing mode [Mode] Off/Mean/Max•Min/P-P	—
	Statistic processing extract mode [Extract] Disc/Overlap	—
	Statistic processing sampling count [Sample] 1/2/3/4/5/6 (See Table 4.3.11-1 for details.)	—
Input Input	Input connector [Input CH] Input1/Input2	—
	Input impedance*2 [Impd2] 50 Ω/1 MΩ	—
	Input ATT*3 [ATT2] On/Off	—

Table 3.2.2-1 Hierarchical Structure of Parameter Setup Screens (Cont'd)

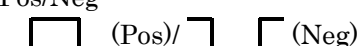
Direct Key	Level 1	Level 2
System Sys	Recall [Recall] 0 to 9	–
	Save [Save] 0 to 9	–
	GPIB [GPIB]	Address setup [Address] 1 to 30
	Config [Config]	Reference signal [Freq Ref] Auto/Int
		AUX [AUX] Off/Go/End/Lvl/Gate/Rest/Acq
		Intensity [Intensity] Off/25%/50%/75%/100%
		System screen [System]

*1: Valid only for signals input to Input1.

*2: Valid only when Input2 is set.

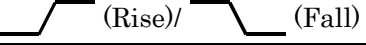
*3: Valid only when Input2 and 1 MΩ are set.

3.2.3 Functions of each key

The unit enters the parameter setup state when a direct key is pressed. The function of each key in the parameter setup state is described below.

(1) Resolution keys

Function as right/left cursor keys.

(2) Sample Rate key



Clears entered items before they are finalized.

(3) Menu keys

Function as numeric, unit, and backspace (BS) keys.

Table 3.2.3-1 shows the function of each key and the Setup LED status in the measurement screen and setup screen.

Table 3.2.3-1 Functions of Keys and Setup LED Statuses in Measurement and Parameter Setup Screens

	Functions			Setup LED
			Direct Keys (Numeric Keys)	
Measurement screen	Resolution setting	Sample rate setting	Direct keys	Off
Setup screen	Cursor	Setting value change*	Direct keys or numeric keys	On

*: For Level acquisition setup and Burst monitor screens

Section 4 Panel Operation

This section describes the panel operations of this unit. Refer to Section 5 “GPIB” for remote control operations using the GPIB.

4.1	Power-On and Self-Check	4-3
4.1.1	Turning on the unit.....	4-3
4.1.2	Self-check	4-4
4.2	Screen Descriptions.....	4-6
4.2.1	Measurement screen.....	4-6
4.2.2	Setup screen	4-11
4.2.3	System screen.....	4-15
4.3	Setting Parameters	4-16
4.3.1	Switching input	4-16
4.3.2	Sample rate	4-17
4.3.3	Frequency resolution	4-18
4.3.4	Measurement mode.....	4-20
4.3.5	Level acquisition	4-21
4.3.6	Frequency acquisition.....	4-22
4.3.7	Burst measurement mode	4-24
4.3.8	Gating function	4-26
4.3.9	Trigger and gate end	4-29
4.3.10	Offset	4-30
4.3.11	Statistical processing.....	4-32
4.3.12	Template function	4-36
4.3.13	Hold	4-37
4.3.14	Restart	4-37
4.3.15	System.....	4-38
4.3.16	High-speed sampling function	4-42
4.3.17	Data storage function	4-43
4.4	Measurement.....	4-44
4.4.1	CW frequency measurement via Input1 (Measurement with frequency acquisition = Auto, level acquisition = Auto)	4-44
4.4.2	CW frequency measurement via Input1 (Measurement with frequency acquisition = Manual, level acquisition = Auto)	4-45
4.4.3	CW frequency measurement via Input1 (Measurement with frequency acquisition = Auto, level acquisition = Manual).....	4-46
4.4.4	Burst wave measurement via Input1 (Measurement with frequency acquisition = Auto, level acquisition = Auto)	4-47

4.4.5	Burst wave measurement via Input1 (Measurement with frequency acquisition = Manual, level acquisition = Auto)	4-49
4.4.6	Burst wave measurement via Input1 (Measurement with frequency acquisition = Manual, level acquisition = Manual)	4-50
4.4.7	Burst wave pulse width and repetition period measurement via Input1	4-51
4.4.8	Burst wave measurement via Input1 using gating function	4-54
4.4.9	Frequency measurement via Input2 (10 MHz to 1 GHz).....	4-57
4.4.10	Frequency measurement via Input2 (10 Hz to 10 MHz)	4-58

4.1 Power-On and Self-Check

4.1.1 Turning on the unit

Turn on the unit, from Step 1, following the procedure below sequentially.

Step 1:

Make sure that the power supply voltage is the proper rating (100 to 120 V or 200 to 240 V, 50 to 60 Hz) and the unit is properly earthed (refer to Sections 2.2 and 2.3).

Step 2:

Turn on the power line switch on the rear panel.

Step 3:

Wait until the unit warms up and the crystal oscillator frequency is stabilized. The warm-up time required for the crystal oscillator to reach the necessary level of stability depends on the crystal oscillator type used, as shown in Table 4.1.1-1 below. The warm-up time is defined as the elapsed time from the moment the power line switch on the rear panel is turned on.

Table 4.1.1-1 Required Warm-Up Time

Crystal Oscillator Type	Activation Characteristics		Aging Rate	
	Warm-Up Time	Rating	Warm-Up Time	Rating
Standard Product	At least 1 hour	$\pm 5 \times 10^{-8}$	At least 24 hours	$\pm 5 \times 10^{-9}/\text{day}$
Option 003	At least 1 hour	$\pm 5 \times 10^{-8}$	At least 72 hours	$\pm 5 \times 10^{-10}/\text{day}$

Step 4:

Turn on the power switch on the front panel.

At this time, if the setting values at the last time the unit was turned off are saved in the backup memory, these values are loaded and applied. If not, the initial setting values described in Appendix A are applied.

It is also possible to turn on the unit with the initial setting values. Turn on the power switch while pressing down the **Enter** key.

Step 5:

Frequency measurement is now possible with this unit.

4.1.2 Self-check

When the unit is turned on, the self-check screen shown in Figure 4.1.2-1 (a) is displayed and a simple self-check is started.

If the self-check is completed successfully, the self-check completion screen shown in Figure 4.1.2-1 (b) is displayed for about one second. The measurement screen is then displayed and measurement starts according to parameters set in advance.

If the simple self-check finds an error with the unit, **Fail** is displayed for the erroneous point (see Figure 4.1.2-1 (c)) and then the unit stops operation.

It is also possible to conduct a detailed self-check by turning on the power switch on the front panel while pressing down the **Return to Meas** key. The screens during a detailed self-check are the same as those during a simple self-check (see Figure 4.1.2-1 (a) and (b)).

If the detailed self-check finds an error with the unit, **Fail** is displayed for the erroneous point (see Figure 4.1.2-1 (d)) and then the unit stops operation.

If the problems discovered during a simple self-check are only GPIB errors (see Figure 4.1.2-1 (e)), it is possible to perform the measurement with the GPIB function cancelled (measurement through panel operation), by pressing the **Preset** key.

The following descriptions are provided, taking the MF2414C as an example. Replace MF2414C in the description with MF2412C or MF2413C when using the MF2412C or MF2413C.

```

Microwave Frequency Counter
MF2414C F/W:1.00 H/W:00
Self-Check executing..
    
```

(a) Self-check (simple and detailed) screen

```

Microwave Frequency Counter
MF2414C F/W:1.00 H/W:00
Self-Check completed.
RAM      :Pass      DISPLAY  :Pass
GPIB-C   :Pass      ASIC      :Pass
    
```

(b) Self-check completed (simple and detailed) screen

```

Microwave Frequency Counter
MF2414C F/W:1.00 H/W:00
Self-Check completed.
RAM      :Pass      DISPLAY  :Pass
GPIB-C   :Pass      ASIC      :Fail
    
```

(c) Self-check failed (simple) screen

```

Anritsu MF2414C F/W:1.00 H/W:00
---- Self-Check ----
RAM      :Pass      DISPLAY  :Pass
GPIB-C   :Pass      ASIC      :Pass
DC        :Pass      PLL Lock :Pass
Freq Meas:Fail
    
```

(d) Self-check failed (detailed) screen

```

Microwave Frequency Counter
MF2414C F/W:1.00 H/W:00
Self-Check completed.
RAM      :Pass      DISPLAY  :Pass
GPIB-C   :Fail      ASIC      :Pass
Press Preset key to continue.
    
```

(e) Self-check GPIB failed (simple) screen

Figure 4.1.2-1 Self-Check Screens

4.2 Screen Descriptions

This unit has three major screens: a measurement screen, a setup screen, and a system screen. The measurement screen consists of two screens: a normal measurement screen and a template screen. The setup screen consists of a menu screen and a burst monitor screen.

This section provides a basic description of screen display.

Table 4.2-1 Screen Configuration

Major	Minor
Measurement screen	Normal measurement screen
	Template screen
Setup screen	Menu screen
	Burst monitor screen
System screen	Self-check result display screen

4.2.1 Measurement screen

When the self-check after power-on is completed normally, the unit enters the measurement state and the measurement screen is displayed. This unit has two kinds of measurement screens: a normal measurement screen and a template screen.

[Normal measurement screen]

Figure 4.2.1-1 shows a normal measurement screen example, where frequency measurement results are indicated by nominal values. This screen is displayed after the initial setup is performed.

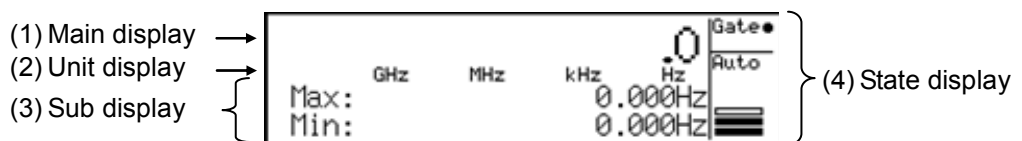

Figure 4.2.1-1 Normal measurement screen

The following describes the items (1) through (4) in Figure 4.2.1-1.

- (1) Main display
Displays frequency measurement results.
- (2) Unit display
Displays units for each set of three digits of frequencies displayed on the main display.

(3) Sub-display

Displayed content changes, depending on what function is specified such as the statistical processing result, offset frequency value, pulse width during burst measurement, and repetition period.

(4) State display

Displays the measurement state. Table 4.2.1-1 lists the measurement states and provides an overview.

Table 4.2.1-1 Measurement State Display

Display	Description
Gate ●	When “●” is displayed next to “Gate”, the frequency of the input signal is being measured. Measurement is stopped when “●” is not displayed.
UNCAL	Displayed when the specifications of the unit cannot be guaranteed because the input signal maintaining the level required to obtain the set resolution is not being supplied continuously.*
Auto 	Displays the unit's level setting and input level.

*: **UNCAL** is displayed in the following case, indicating the measurement is not valid.

- The input signal level is out of the measurable range.
- The set measurement resolution cannot be obtained from the measurement result.
- A burst signal that has a pulse width with which a settable measurement resolution cannot be obtained, even if it is averaged, is input during burst carrier frequency measurement.
- Input2 is selected as the signal input terminal connector when the burst measurement mode is set.

The level display of the (4) State display in Figure 4.2.1-1 is described below (see Figure 4.2.1-2).

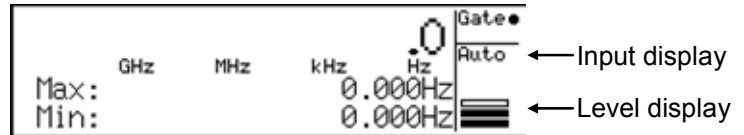

Figure 4.2.1-2 Level display

The level display consists of the input display showing how to handle the input signal and the level display showing the power of the input signal. Table 4.2.1-2 describes the items displayed in the input display, and Table 4.2.1-3 describes the indication in the level display.

Table 4.2.1-2 Items in Input Display

Displayed Item	Description
Auto	Indicates that Input1 is selected and the level acquisition mode is set to Auto, or that Input2 is selected and the impedance is set to 50 Ω.
L0 to L7	Indicates that the amplitude discrimination value is set to one of L0 to L7 when Input1 is selected and the level acquisition mode is set to Manual.
ATTon	Indicates that the 20-dB attenuator is set to On when Input2 is selected and the input impedance is set to 1 MΩ.
No display	Indicates that Input2 is selected and the input impedance is set to 1 MΩ.

Table 4.2.1-3 Indication in Level Display

Indication	Description
Over ██████ ██████ ██████	Indicates that the input level is too high. Measurement cannot be performed normally until the input level is lowered.
▬ ██████ ██████	Indicates that the input level is proper.
▬ to ██████ ▬ to ██████ ██████ to ██████	Indicates that the input level is measurable.
▬ ▬ ▬	Indicates that the input level is too low. Measurement cannot be performed normally until the input level is raised.

[Template screen]

Figure 4.2.1-3 shows the template screen, which visually indicates whether the frequency measurement results fall within the preset range. This screen allows making a decision instantly during adjustment, without calculating frequency values.

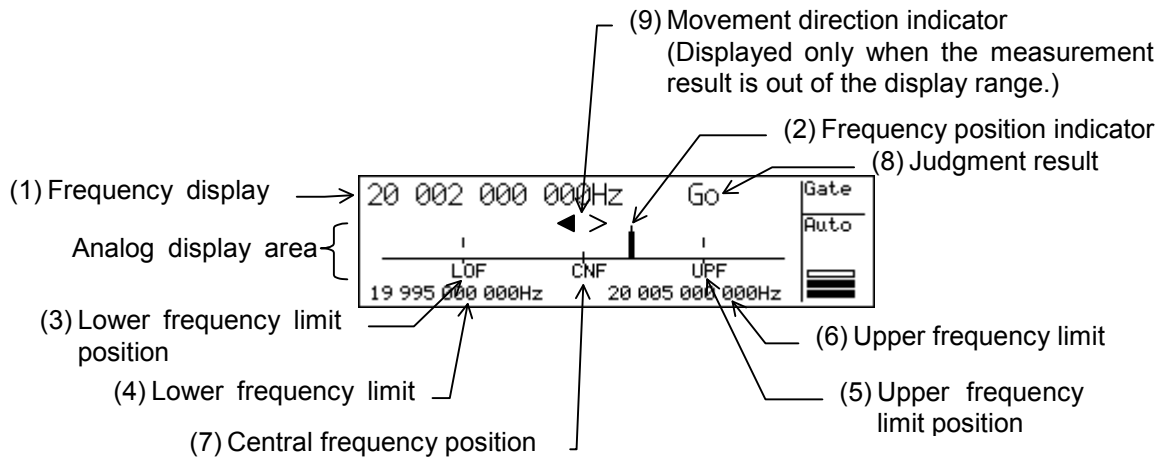

Figure 4.2.1-3 Template Screen

The following describes the items (1) through (9) in Figure 4.2.1-3.

- (1) Frequency display
Displays the frequency measurement results.
- (2) Frequency position indicator
Indicates the position of the measured frequency within the range set in advance by the upper frequency limit and the lower frequency limit. If the measured frequency exceeds the LCD display range, the frequency position indicator is held at the left or right end.
- (3) Lower frequency limit position
Indicates the set lower frequency limit on the LCD.
- (4) Lower frequency limit
Displays the set lower frequency limit value.
- (5) Upper frequency limit position
Indicates the set upper frequency limit on the LCD.
- (6) Upper frequency limit
Displays the set upper frequency limit value.
- (7) Central frequency position
Indicates the position of the central frequency obtained from the upper and lower frequency limits.

(8) Judgment result

The measured result is judged regarding whether it is within the frequency range determined by the upper and lower frequency limits, and the judgment result is displayed.

Within the range: Displays “Go”

Outside of the range: Displays “No-Go”

(9) Movement direction indicator

When the measured frequency value is out of the LCD display range, the measured frequency value is compared with the previously measured value to find out whether the frequency is falling or rising, and the direction of movement is displayed here.

The movement direction indicator can be displayed (on) or hidden (off) by setting the parameter.

Table 4.2.1-4 shows the meaning of the display of the movement direction indicator.

Table 4.2.1-4 Movement Direction Indicator

Indicator	Description
◀ >	Indicates that the measured frequency value is moving to the left (lower frequency direction).
< ▶	Indicates that the measured frequency value is moving to the right (higher frequency direction).
< >	Indicates that the measured frequency value is constant.

4.2.2 Setup screen

When a direct key is pressed when the unit is in the measurement state (the measurement screen is displayed and the Setup LCD on the front panel goes off), the unit enters the parameter setup state (the setup screen is displayed and the Setup LCD on the front panel lights up). The following describes the two types of setup screens.

[Menu Screen]

The menu screen displays a list of menu items corresponding to the direct key pressed. Use the \leftarrow and \rightarrow keys to select parameters and setting values, and enter numeric data. Figure 4.2.2-1 shows a menu screen example.



Figure 4.2.2-1 Menu Screen

The following describes the items (1) through (4) in Figure 4.2.2-1.

(1) Frequency

Displays the frequency measurement results.

(2) Setting display

Displays numeric data, such as frequencies. This area is also used as a response display area, in which numeric values entered from the numeric keypad are displayed as they are.

(3) Menu

- The menu displays up to four function selections at the same time. For the sake of convenience, these function are called F1, F2, F3, and F4, starting from the left.
- A function selected by the \leftarrow and \rightarrow keys is highlighted and displayed within a thick frame.
- The structure of each menu is as follows:

- (a)

Function name
[Setting state]

 ← Displays the name of the function.
 ← The content in brackets indicates the value of the selected parameter.
- (b)



Lower screen
*

 ← When the menu can extend to a lower level, the group name is displayed affixed with an asterisk (*).

Section 4 Panel Operation

- The menu operation methods are described below.
 - Select a menu (F1 through F4) to be set using the \leftarrow and \rightarrow keys.
 - Set the parameters as necessary. The setup procedure differs depending on the selected menu. See Table 4.2.2-1 below.

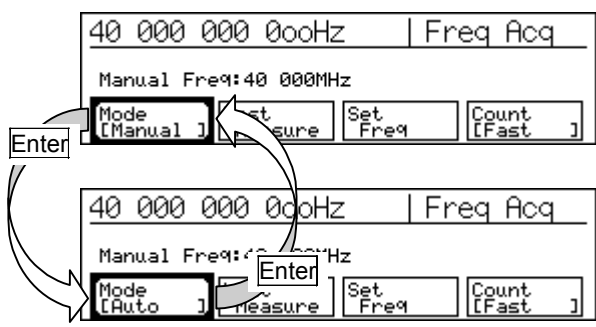
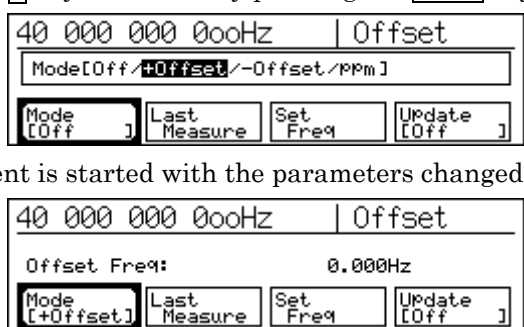
Table 4.2.2-1 Parameter Setup Procedure

Parameter Type	Setup Procedure
<p>Menu with two selections Ex.: [On/Off], [Auto/Manual]</p>	<p>Parameters are changed alternately by pressing the Enter key. The following figure shows an example of [Auto/Manual]. If the Enter key is pressed when [Manual] is selected, [Auto] is selected, and vice versa.</p>  <p>Measurement starts once the parameter is switched.</p>
<p>Menu with three or more selections Ex.: [Off/Offset/ppm]</p>	<p>Pressing the Enter key pops up a parameter menu. Select a parameter using the \leftarrow and \rightarrow keys and fix it by pressing the Enter key.</p>  <p>The measurement is started with the parameters changed and fixed.</p>
<p>Numeric value input menu Ex.: [Manual Freq]</p>	<p>Select a menu that requires numeric value input, and then press the Enter key. The setting value display is highlighted, enabling numeric values to be input using the numeric keypad. When a numeric value is input, this area becomes a response data display area that displays the input numeric value. Pressing the unit key fixes the input value and starts the measurement. The setting value is still highlighted at this time, allowing another numeric value to be input. Press the Enter, Return to Meas, \leftarrow or \rightarrow key to exit from the numeric value input mode.</p> 

(4) Title

Displays the title given to each setup screen.

See Table 3.2.2-1 for the parameters that can be set using the direct keys and the menu screen.

[Burst Monitor Screen]

The trigger delay value and gate width can be set in this screen. Pressing **TD** or **GW** displays the burst monitor screen shown in Figure 4-2.2-2 below. Values can be set while monitoring the detection signal for input signals of one burst.

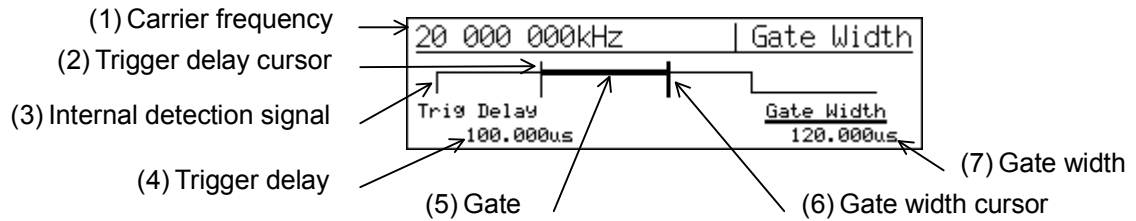

Figure 4.2.2-2 Burst monitor screen

- (1) Carrier frequency
Displays the carrier frequency measured by the currently selected gate.
- (2) Trigger delay cursor
Shows the position of the trigger delay. The cursor moves right and left according to the trigger delay value.
- (3) Internal detection signal
Displays the burst detection signal.
- (4) Trigger delay
Displays the trigger delay.
- (5) Gate
Displays the gate interval using a thick line. The gate interval moves right and left according to the trigger delay and gate width.
- (6) Gate width cursor
Indicates the gate width. The cursor moves to the right and left according to the gate width.
- (7) Gate width
Displays the gate width.

The parameter that can be set is highlighted. Use the cursor keys, **←** and **→**, and numeric keypad to make settings.

4.2.3 System screen

Figure 4.2.3-1 shows the system screen that displays self-check results. The simple self-check result system screen is displayed, following the start screen after power-on. The detailed self-check results system screen is displayed when the **Sys** key is pressed and [Config] and [System] are then selected from the menu.

```
Microwave Frequency Counter
MF2414C F/W:1.00 H/W:00
Self-Check completed.
RAM      :Pass      DISPLAY  :Pass
GPIB-C   :Pass      ASIC     :Pass
```

(a) Simple self-check result system screen

```
Anritsu MF2414C F/W:0.40 H/W:00
---- Self-Check ----
RAM      :Pass      DISPLAY  :Pass
GPIB-C   :Pass      ASIC     :Pass
DC       :Pass      PLL Lock :Pass
Freq Meas:Pass
```

(b) Detailed self-check result system screen

Figure 4.2.3-1 System screens

4.3 Setting Parameters

This section describes the parameters and their setting method.

When parameter settings are changed by using the panel keys, frequency measurement or statistical processing is restarted and a new measurement is performed.

When parameters are changed in the hold state, frequency measurement or statistical processing is performed once and the unit returns to the hold state.

4.3.1 Switching input

The connector and signal input impedance for the signal to be measured can be selected, and the attenuator setting can be configured in the screen shown in Figure 4.3.1-1. This screen is displayed by pressing the **Input** key.



Figure 4.3.1-1 Input Switching Screen

(1) Menu F1: Input CH

Selects the connector for inputting the signal to be measured along with the measurement frequency. The following shows the correspondence between the selected connector and frequency ranges:

Input1: 600 MHz to 20 GHz (for MF2412C)
 600 MHz to 27 GHz (for MF2413C)
 600 MHz to 40 GHz (for MF2414C)

Input2: 10 Hz to 1 GHz (common to MF2412C/MF2413C/MF2414C)

(2) Menu F2: Impd2

Selects the input impedance for Input2. The impedance can be switched between 50 Ω and 1 MΩ for Input2, though the input impedance for Input1 is fixed to 50 Ω. The following shows the correspondence between the selected impedance and frequency ranges:

50 Ω: 10 MHz to 1 GHz
 1 MΩ: 10 Hz to 10 MHz

(3) Menu F3: ATT2

Enables (on) or disables (off) the 20-dB attenuator inserted in the Input2 1-MΩ system.

4.3.2 Sample rate

Sample rate refers to a measurement pause time from the end of a measurement to the start of the next measurement. It can be set to from 1 ms to 10 seconds.

The sample rate can be set using the \uparrow and \downarrow keys when the measurement screen is displayed.

Press the \uparrow key to set a long time, and the \downarrow key to set a short time.

Figure 4.3.2-1 shows a sample rate setup screen example.

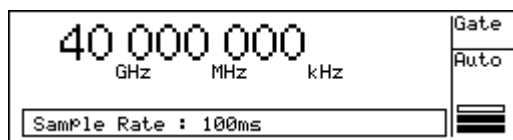



Figure 4.3.2-1 Sample Rate Setup Screen

Notes:

- When automatic frequency acquisition measurement is set for Input1, the minimum sample rate is 10 ms. (Even if the sample rate is set to 5 ms or less, measurement will be performed at a sample rate of 10 ms.)
- When the frequency acquisition mode is set to Auto in the burst measurement mode, the pause time may be longer than the set sample rate, depending on the pulse width and period of the pulse modulation signal.

4.3.3 Frequency resolution

The number of display digits of frequency measurement results can be set using the  and  keys. The frequency setting range varies depending on the difference between the input channel and impute impedance, selected previously, and the settable measurement resolution is accordingly varies.

Tables 4.3.3-1 and 4.3.3-2 show the settable resolutions.

Table 4.3.3-1 Frequency display (with input impedance = 50 Ω)

• Input connector: Input1 (50 Ω), Input2 (50 Ω)





Measurement Resolution	Display	 Key Function	 Key Function
0.1 Hz	20 000 000 000.0 GHz MHz kHz Hz		
1 Hz	20 000 000 000. GHz MHz kHz Hz		
10 Hz	20 000 000 000 GHz MHz kHz Hz		
100 Hz	20 000 000 000 GHz MHz kHz Hz		
1 kHz	20 000 000 GHz MHz kHz Hz		
10 kHz	20 000 000 GHz MHz kHz Hz		
100 kHz	20 000 000 GHz MHz kHz Hz		
1 MHz	20 000 GHz MHz kHz Hz		

Table 4.3.3-2 Frequency display (with input impedance = 1 MΩ)

• Input connector: Input2 (1 MΩ)

Measurement Resolution	Display	⏪ Key Function	⏩ Key Function
1 mHz	10 000 000.000 GHz MHz kHz Hz	↓	↑
10 mHz	10 000 000.00 GHz MHz kHz Hz		
100 mHz	10 000 000.0 GHz MHz kHz Hz		
1 Hz	10 000 000. GHz MHz kHz Hz		
10 Hz	10 000 000 GHz MHz kHz Hz		
100 Hz	10 000 000 GHz MHz kHz Hz		
1 kHz	10 000 GHz MHz kHz Hz		
10 kHz	10 000 GHz MHz kHz Hz		
100 kHz	10 000 GHz MHz kHz Hz		
1 MHz	10 GHz MHz kHz Hz		

When measuring the carrier frequency of a burst signal, the pulse width of the burst signal determines the maximum frequency resolution that can be measured. When the set frequency resolution is higher than the maximum frequency resolution that can be measured, **UNCAL** is displayed in the screen and then the frequency measurement is performed at the maximum frequency resolution possible.

For example, when the frequency resolution is set to 1 kHz and the measurement result could only obtain a resolution up to 10 kHz, the screen display becomes as follows:

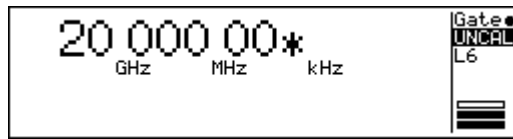

Figure 4.3.3-1 UNCAL display example

Figure 4.3.3-2 shows the relationship between the burst pulse width and the maximum frequency resolution.

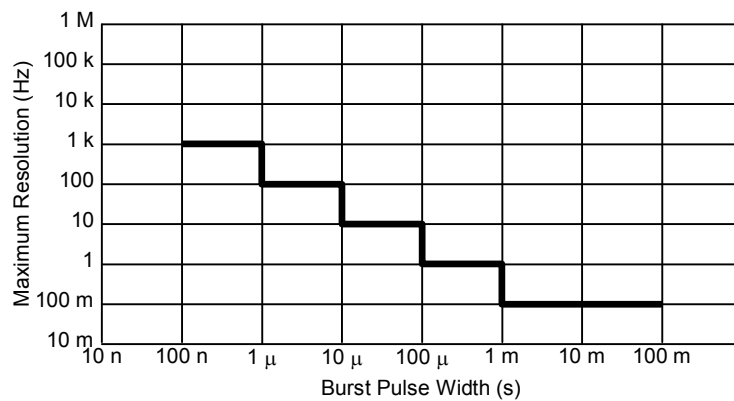

Figure 4.3.3-2 Pulse Width vs. Maximum Frequency Resolution

4.3.4 Measurement mode

Whether to measure burst waves or continuous waves (CW) can be selected by using the **Meas Mode** key. To measure burst waves, press the **Meas Mode** key so that the Burst LED lights up. To measure continuous waves (CW), press the **Meas Mode** key so that the Burst LED goes off.

In burst measurement, carrier frequency, pulse width, and pulse repetition period can be measured.

The Input2 connector cannot be used for burst measurement. Make sure to select continuous measurement when Input2 is selected.

4.3.5 Level acquisition

Level acquisition can be performed only when Input1 is selected. Whether to set the optimum amplitude discrimination value (level acquisition) according to the input signal in the Auto or Manual mode can be selected. When Manual is selected for level acquisition, set the manual amplitude discrimination value from the maximum attenuation level 0 (L0, attenuation of 42 dB) to the minimum attenuation level 7 (L7, attenuation of 0 dB), in 6-dB steps.

Pressing the **Level** key displays the level acquisition setup screen shown in Figure 4.3.5-1. The manual amplitude discrimination value can be set in this screen, using **▲** and **▼** keys.



Figure 4.3.5-1 Level Acquisition Setup Screen

- (1) Menu F1: Mode
Select Auto or Manual for level acquisition.
When Auto is selected, the level is automatically set to the optimum reception level.
When Manual is selected, also set the manual amplitude discrimination value.
- (2) Menu F2: Last Measure
Sets the amplitude discrimination value set in the Auto mode, as the manual amplitude discrimination value.
- (3) Menu F3: ▲
When the **Enter** key is pressed with menu F3 selected, the manual amplitude discrimination value is incremented by 1. Use this when the input level is low. The manual amplitude discrimination value can be incremented up to L7.
The **▲** key can be used to increment the manual amplitude discrimination value even if menu F3 is not selected.
- (4) Menu F4: ▼
When the **Enter** key is pressed with menu F4 selected, the manual amplitude discrimination value is decremented by 1. Use this when the input level is high. The manual amplitude discrimination value can be decremented up to L0.
The **▼** key can be used to decrement the manual amplitude discrimination value even if menu F4 is not selected.

4.3.6 Frequency acquisition

Frequency acquisition can be performed only when Input1 is selected. Whether to set the acquisition frequency value in the Auto or Manual mode can be selected. When Manual is selected for frequency acquisition, set the acquisition frequency value (manual frequency value) in 1-MHz steps.

The settable frequency ranges are as follows:

- MF2412C: 600 MHz to 20 GHz
- MF2413C: 600 MHz to 27 GHz
- MF2414C: 600 MHz to 40 GHz

Pressing the **Freq** key displays the frequency acquisition setup screen shown in Figure 4.3.6-1. Set the parameters as necessary, in this screen.



Figure 4.3.6-1 Frequency Acquisition Setup Screen

(1) Menu F1: Mode

Select Auto or Manual for frequency acquisition.

When Auto is selected, the input frequency is automatically acquired and measured.

When Manual is selected, the frequency obtained by adding the input tolerance to the manual frequency value is measured. Make sure to set the manual frequency value.

Tables 4.3.6-1 and 4.3.6-2 show the input tolerances.

Table 4.3.6-1 Input Tolerance (CW Measurement)

Manual Frequency Value	Input Tolerance
600 MHz to 1 GHz	±30 MHz
1 GHz or higher	±40 MHz

Table 4.3.6-2 Input Tolerance (Burst Measurement)

Manual Frequency Value	Burst Width Setting	Input Tolerance
600 MHz to 1 GHz	Wide	±30 MHz
	Narrow	±20 MHz
1 GHz or higher	Narrow	±20 MHz
	Wide	±40 MHz

Note:

Manual mode operation is not guaranteed when the manual setting value for the input signal exceeds the input tolerance. If this happens, an incorrect measurement result may be displayed. Check the input signal before deciding the manual setting value.

(2) Menu F2: Last Measure

Sets the frequency measurement result as a manual frequency value.

(3) Menu F3: Set Freq

Select this menu to set the manual frequency value.

Select [Set Freq] and press the **Enter** key. Manual Freq is highlighted, and a manual frequency value can be input from the numeric keypad.

Figure 4.3.6-2 shows an example where “12” is input from the numeric keypad. Pressing the **GHz** key at this time sets 12 GHz as the acquisition frequency value, and measurement is started.



Figure 4.3.6-2 Setting Manual Frequency

After a numeric value is input and the measurement unit is set, Manual Freq is still highlighted, allowing another frequency to be input.

Press the **Enter**, **←**, **→**, or **Return to Meas** key to exit from the numeric value input mode.

(4) Menu F4: Count

Sets the count method to either Fast or Normal.

When Fast is selected, pressing the **Enter** key with menu F4 selected newly sets “Normal”.

When Fast is set, the unit performs counting using the reciprocal method.

When Normal is set, the unit performs counting using the direct count method. However, when Meas Mode is set to Burst, the unit counts using the Fast (reciprocal) method even if Mode is set to Normal.

4.3.7 Burst measurement mode

The burst measurement mode is only available when Meas Mode is set to Burst. Select carrier frequency, burst width, or burst repetition period for the burst measurement target. In addition, set whether to perform burst width measurements and burst period measurements with burst On (positive polarity) or burst Off (negative polarity) and set the burst wave to be measured to correspond to the burst width.

Table 4.3.7-1 shows the measurement range.

Table 4.3.7-1 Relationship between Burst Measurement Target and Burst Measurement Polarity

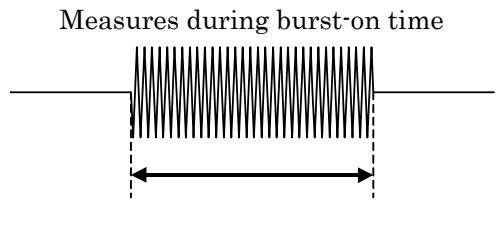
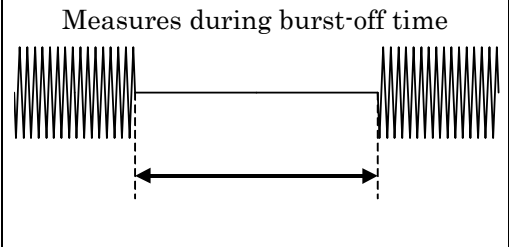
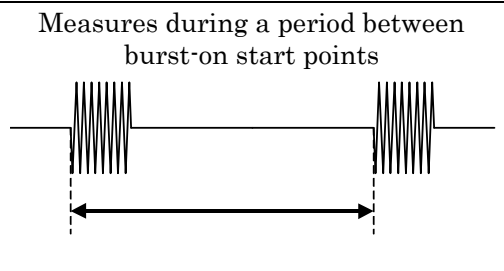
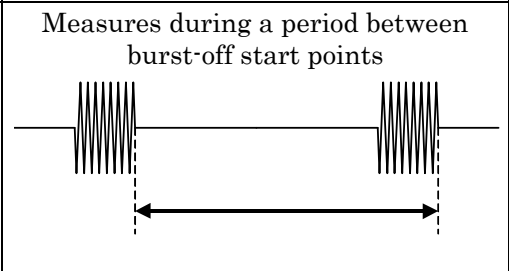
		Burst Measurement Polarity	
		Positive	Negative
Measurement Item	Burst Width	Measures during burst-on time 	Measures during burst-off time 
	Burst Period	Measures during a period between burst-on start points 	Measures during a period between burst-off start points 

Pressing the **Burst** key displays the burst mode screen shown in Figure 4.3.7-1. Set the parameters as necessary, in this screen.



Figure 4.3.7-1 Burst Mode Screen

(1) Menu F1: Mode

Sets whether to measure carrier frequency, burst width, or burst repetition period.

Pressing the **Enter** key with menu F1 selected displays the burst mode selection screen shown in Figure 4.3.7-2.

Select **Freq**, **Width**, or **Period** using the cursor keys, and then press the **Enter** key to fix the selection. The burst mode screen (Figure 4.3.7-1) is displayed again, with the set parameter displayed in brackets of menu F1.

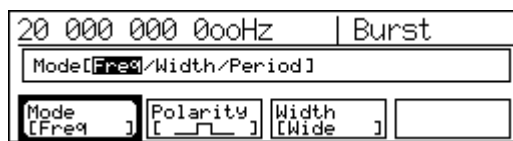

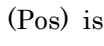

Figure 4.3.7-2 Burst Mode Selection Screen

(2) Menu F2: Polarity

Sets the polarity (positive/negative) for burst measurement.

When positive polarity is set, pressing the **Enter** key with menu F2 selected changes the polarity to negative, and Polarity [] (Neg) is displayed on the screen. Conversely, pressing the **Enter** key with menu F2 selected when negative polarity is selected changes the polarity to positive, and Polarity [] (Pos) is displayed.

(3) Menu F3: Width

Selects Wide or Narrow according to the width of the burst wave to be measured.

Table 4.3.7-2 shows the measurable burst widths and input tolerances for each setting (Wide/Narrow).

Table 4.3.7-2 Relationships between Measurable Burst Width and Input Tolerance for Each Burst Width Setting (Wide/Narrow)

Burst Width	Measurable Range	Input Tolerance	Carrier Frequency
Wide	1 μ s to 0.1 s	± 30 MHz	0.6 to 1 GHz
		± 40 MHz	≥ 1 GHz
Narrow*	100 ns to 0.1 s	± 20 MHz	≥ 1 GHz

*: Narrow setting is valid only when the manual frequency value is 1 GHz or higher. If the manual frequency value is less than 1 GHz, measurement will be performed in Wide mode.

4.3.8 Gating function

The gating function measures a frequency in any interval of the measured signal to be input to the counter. Based on the trigger signal, it defines the interval for measuring the frequency according to the specified parameters such as a trigger delay, gate width, and gate end.

Note that the signal to be measured at the prescribed level must exist in the measurement interval. Figure 4.3.8-1 shows the relationships between the parameters.

This function enables measuring of the frequency at a specific position of a burst signal.

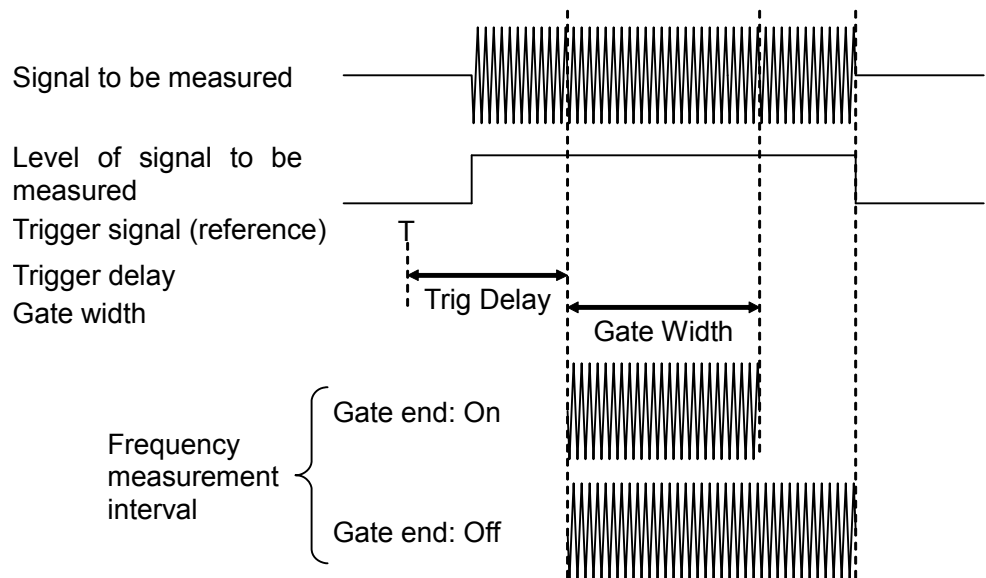

Figure 4.3.8-1 Gating Function Overview

The trigger delay width and gate width can be set while checking the burst signal on/off state displayed on the screen.

The trigger delay width can be set from 0 ns to 100 ms. The setting resolutions are as table 4.3.8-1:

Table 4.3.8-1 Relationships between Trigger Delay Width and Setting Resolution

Trigger Delay Width	Setting Resolution
0 to 320 ns	20 ns
320 ns to 1 μ s	40 ns
1 μ s to 100 ms	Number of significant bits: 2

The gate width can be set from 100 ns to 100 ms. The setting resolutions are listed in Table 4.3.8-2.

When “Wide” is set for the burst width, the minimum value of the gate width becomes 1 μ s. At this time, if a value less than 1 μ s is set as the gate width, measurement will be performed at the gate width of 1 μ s.

Table 4.3.8-2 Relationships between Gate Width and Setting Resolution

Gate Width	Setting Resolution
100 ns to 1 μ s	20 ns
1 μ s to 100 ms	Number of significant bits: 2

Pressing the **TD** key displays the burst monitor screen for trigger delay setting shown in Figure 4.3.8-2. The trigger delay value can be set using the \blacktriangleleft and \blacktriangleright keys. Pressing the \blacktriangleleft key increases the trigger delay value, and pressing the \blacktriangleright key decreases the trigger delay value.

To input a numeric value using the numeric keypad, press the **Enter** key at this timing. “Trig Delay” is highlighted, and a numeric value can be input (numeric value input mode). After inputting a value, press the **Enter** key to display Trig Delay (underscored).

Pressing the \blacktriangleleft or \blacktriangleright key displays Gate Width (underscored), allowing the gate width to be set. Pressing the \blacktriangleleft or \blacktriangleright key at this time displays Trig Delay (underscored), allowing the delay width from the trigger to be set.

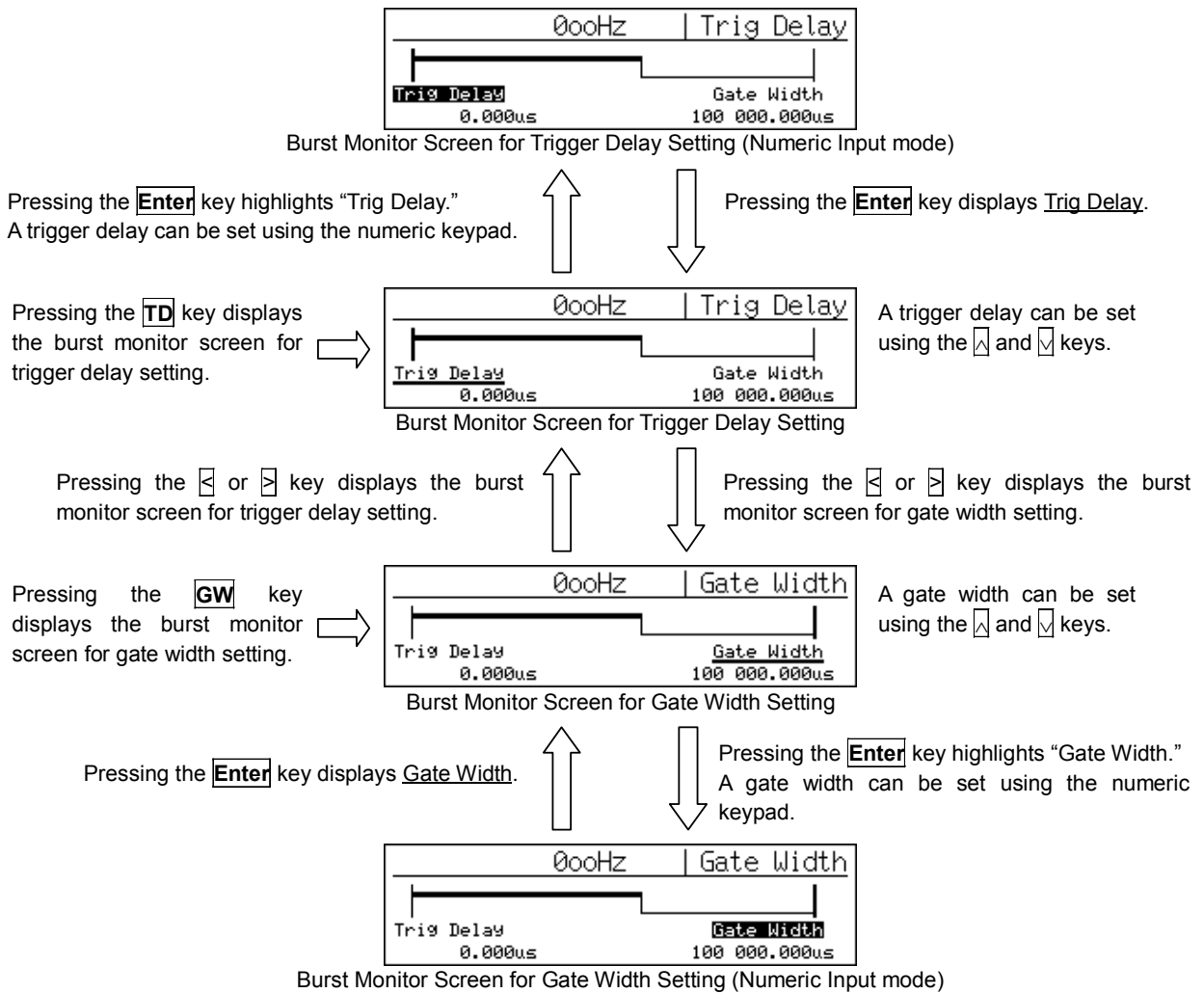

Figure 4.3.8-2 Transition of Burst Monitor Screens

Pressing the **GW** key displays the burst monitor screen for gate width setting shown in Figure 4.3.8-2. The gate width can be set using the **▲** and **▼** keys. Pressing the **▲** key increases the gate width, and pressing the **▼** key decreases the gate width.

Switching to the numeric value input mode, and the **▲** and **▼** key functions are the same as those for the burst monitor screen for trigger delay setting.

4.3.9 Trigger and gate end

This function selects the trigger signal identifying the start of frequency measurement, select trigger polarity, and sets the gate end.

Pressing the **Trig** key displays the trigger setup screen shown in Figure 4.3.9-1. Set the parameters as necessary, in this screen.

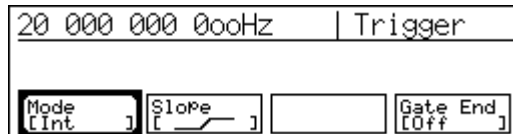

Figure 4.3.9-1 Trigger Setup Screen

(1) Menu F1: Mode

Selects the trigger from internal trigger (Int), external trigger (Ext), and line trigger (Line).

Selecting menu F1 displays the trigger selection screen shown in Figure 4.3.9-2. Select **Int**, **Ext**, or **Line** using the cursor keys, and then press the **Enter** key to fix the selection. The trigger setup screen (Figure 4.3.9-1) is displayed again, with the set parameter displayed in brackets of menu F1.

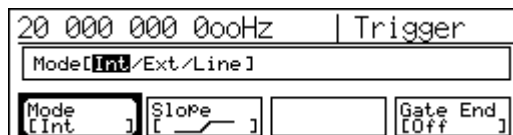

Figure 4.3.9-2 Trigger Selection Screen

(2) Menu F2: Slope

Sets the polarity (rising/falling) for detecting an external trigger signal and line trigger.

(3) Menu F4: Gate End

Sets whether to use gate width for finishing the carrier frequency measurement.

When Gate End is set to On, carrier frequency is measured using the gate within the width set by the gate value. When Gate End is set to Off, carrier frequency is measured using the gate within a width until the burst wave goes to “Off”.

Note:

When Gate End is On, set the trigger delay and gate width so that their timings are sufficiently before the timing when the burst waves are turned Off. When there isn't enough interval from Gate End to the burst waves' turning Off, the expected results may not be obtained.

4.3.10 Offset

This function uses the offset frequency value set in advance, to perform the following calculations for the measured frequency and display the results.

- +Offset: Adds the offset value to the measured frequency value.
- Offset: Subtracts the offset value from the measured frequency value.
- ppm: Obtains the deviation from the measured frequency value and displays it in parts per million.

Pressing the **Ofs** key displays the offset parameter setup screen shown in Figure 4.3.10-1. Set the parameters as necessary, in this screen.



Figure 4.3.10-1 Offset Parameter Setup Screen

(1) Menu F1: Mode

Sets the offset mode.

Pressing the **Enter** key with menu F1 selected displays the offset mode selection screen shown in Figure 4.3.10-2.

Select **Off**, **+Offset**, **-Offset**, or **ppm** using the **←** and **→** keys, and then press the **Enter** key. The offset parameter setup screen (Figure 4.3.10-1) is displayed again, with the selected parameter displayed in brackets of menu F1.



Figure 4.3.10-2 Offset Mode Selection Screen

(2) Menu F2: Last Measure

Pressing the **Enter** key with menu F2 selected sets the measured frequency value at that time as the offset frequency value.

(3) Menu F3: Set Freq

Select this menu to set the offset frequency using the numeric keypad.

Select [Set Freq] and press the **Enter** key. Offset Freq is highlighted and an offset frequency value can be input using the numeric keypad.

Press the **Enter**, \leftarrow , \rightarrow , or **Return to Meas** key to exit from the numeric value input mode.

The offset frequency can be set from 0 Hz to F_{\max} , in 1-mHz steps.

F_{\max} = 20 GHz (for MF2412C)

27 GHz (for MF2413C)

40 GHz (for MF2414C)

(4) Menu F4: Update

Enables (on) and disables (off) the update mode.

When the update mode is enabled (on), the unit sequentially updates using the previous measurement value as an offset value.

Figure 4.3.10-3 shows the displayed values when $-Offset$ is selected while the update mode is enabled.

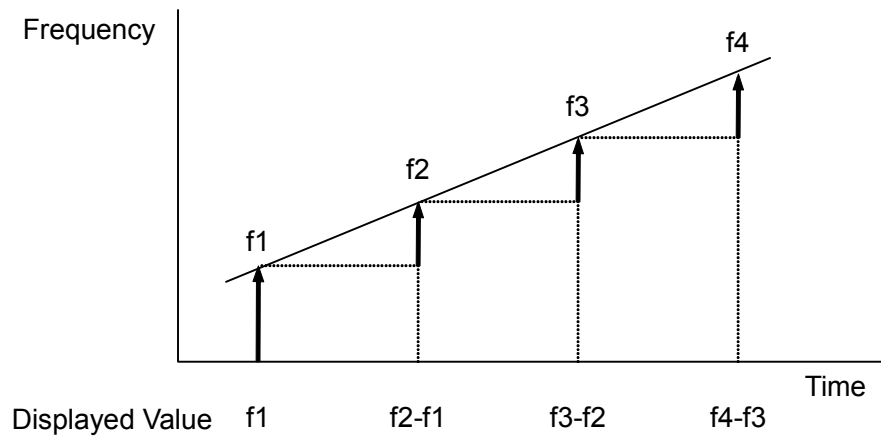

Figure 4.3.10-3 Displayed values when Update = On and $-Offset$ is selected

4.3.11 Statistical processing

This function calculates mean, minimum, and maximum values from frequency measurement results, and then displays the calculation results. Whether to calculate the mean, minimum, or maximum value, or perform another calculation, can be selected in the statistical processing mode setup screen. The statistical processing mode is described in “(1) Menu F1: Mode” below.

Statistical processing requires collecting many data (samples) to be used for calculation. Make sure to set the number of necessary samples (frequency measurement count) in advance, as the sample count. The sample count is described in “(3) Menu F3: Sample” below.

It is also required to set the combination of the collected sample data for calculation. How to set a combination is described in “(2) Menu F2: Extract” below.

Pressing the **Stat** key displays the statistical processing parameter setup screen shown in Figure 4.3.11-1. Set the parameters as necessary, in this screen.



Figure 4.3.11-1 Statistical Processing Parameter Setup Screen

(1) Menu F1: Mode

Sets the statistical processing mode.

The statistical processing mode selection screen shown in Figure 4.3.11-2 is displayed when menu F1 is selected.

Select **Off**, **Mean**, **Max**, **Min**, or **P-P** using the \leftarrow and \rightarrow keys, and then press the **Enter** key. The statistical processing mode selection screen (Figure 4.3.11-1) is displayed again, with the selected parameter displayed in brackets of menu F1.



Figure 4.3.11-2 Statistical Processing Mode Selection Screen

In a statistical processing mode, the following processing will be performed depending on the selected statistical processing extraction mode. D_n and N indicate the n -th measurement value and the set number of samples, respectively.

- Mean (Extraction mode: Discrete)

The arithmetic average value of the measurement values for the number of samples N is calculated.

$$\text{Mean} = (1/N) \cdot \left\{ \sum_{i=1}^N (D_i) \right\}$$

- Mean (Extraction mode: Overlap)

The moving average value of the measurement values for the number of samples N is calculated.

$$\text{Mean} = (1/N) \cdot \left\{ \sum_{i=n-N+1}^n (D_i) \right\} \quad \text{where, } n \geq N$$

- Max•Min (Extraction mode: Discrete)

Max = Maximum (D_i , $i = 1, 2, \dots, N$)

Min = Minimum (D_i , $i = 1, 2, \dots, N$)

- Max•Min (Extraction mode: Overlap)

Max = Maximum (D_i , $i = n-N+1, \dots, n-1, n$)

Min = Minimum (D_i , $i = n-N+1, \dots, n-1, n$) where, $n \geq N$

- P-P

P-P = Max - Min

Note:

When Max or Min is selected, the display on the screen is the same (Max on the upper row and Min on the lower row), but the response value to the data collection by remote control via the GPIB (issuance of MSTA or OM) is different.

Refer to Section 5.4.4 “Device message list” for details.

(2) Menu F2: Extract

Sets Overlap/Disc (Discrete) for the statistical processing extraction mode.

In the Discrete mode, statistical processing results are output each time data is collected for the specified sample count.

In the Overlap mode, statistical processing results are output first when data is collected for the specified sample count, and then the results are output each time data of one sample is collected.

Figure 4.3.11-3 shows the processing in each mode.

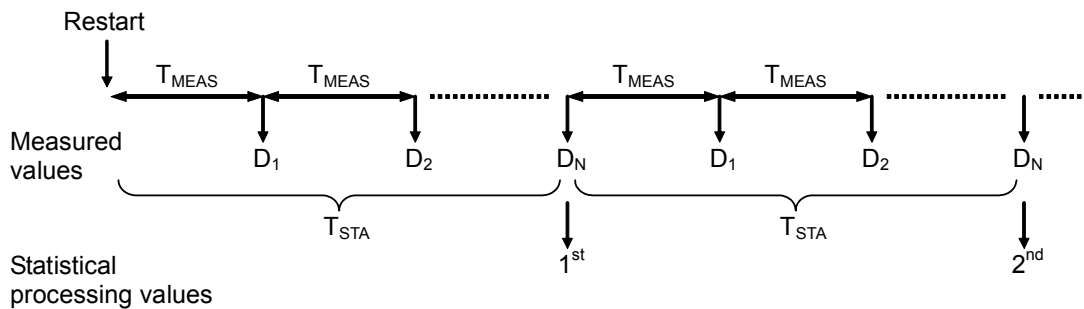

where, N: Sample count
 T_{MEAS} : Measurement repetition period = Acquisition time^{*1} + Measurement time^{*2} + Sample rate
 T_{STA} : Statistical processing time = Sample count $N \times T_{MEAS}$

(a) Statistical processing in Discrete mode

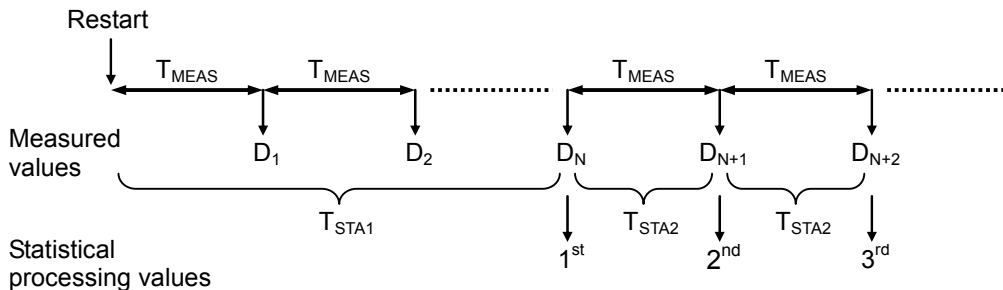

where; N: Sample count
 T_{MEAS} : Measurement repetition period = Acquisition time^{*1} + Measurement time^{*2} + Sample rate
 T_{STA1} : Statistical processing time 1 = Sample count $N \times T_{MEAS}$
 T_{STA2} : Statistical processing time 2 = T_{MEAS}

(b) Statistical processing in Overlap mode

Figure 4.3.11-3 Statistical Processing Extraction Mode

*1: The acquisition time is generated at an acquisition loss when automatic acquisition processing is set.

*2: The measurement time is determined by the frequency of the input signal and the measurement resolution.

(3) Menu F3: Sample

Sets n for the sample count (2^n : Overlap mode, about 10^n : Discrete mode).

When menu F3 is selected, the sample count selection screen shown in Figure 4.3.11-4 is displayed. Select 1, 2, 3, 4, 5, or 6 using the \leftarrow and \rightarrow keys, and then press the **Enter** key. The statistical processing mode selection screen (Figure 4.3.11-1) is displayed again, with the selected parameter displayed in brackets of menu F3.



Figure 4.3.11-4 Sample Count Selection Screen

Table 4.3.11-1 shows the correspondence between the statistical processing sample counts and the statistical processing extraction modes.

Table 4.3.11-1 Correspondence between Extraction Mode and Sample Count

Parameter \ Extraction Mode	1	2	3	4	5	6
Discrete	10 (16)*	100 (128)*	1000 (1024)*	10000 (16384)*	100000 (131072)*	1000000 (1048576)*
Overlap	2	4	8	16	32	64

*: Actual sample count in the Discrete mode (10^n should be taken as a rough indication.)

4.3.12 Template function

This function displays the frequency of the signal being measured, judges whether the measured frequency is within the range of the upper and lower frequency limits, and then displays Go/No-Go for the judgment result. The judgment result can be output from the Aux terminal in the TTL level. In addition, the indicator can be displayed as shown in Figure 4.3.12-1, to visually indicate whether the measured result falls into the previously set range.

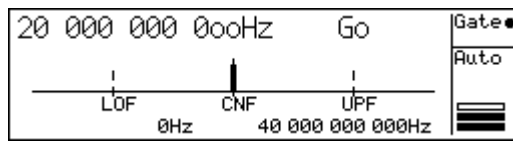

Figure 4.3.12-1 Measurement Screen Using Template Function

Pressing the **Temp** key displays the template setup screen shown in Figure 4.3.12-2. Set the template function parameters as necessary, in this screen.

Pressing the **Return to Meas** key while the template function is enabled displays the measurement screen shown in Figure 4.3.12-1.

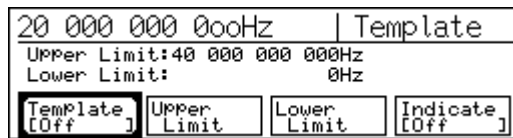

Figure 4.3.12-2 Template Setup Screen

- (1) Menu F1: Template
Enables (on) or disables (off) the template function.
- (2) Menu F2: Upper Limit
Select this menu to set the upper frequency limit value*, using the numeric keypad on the front panel.
When this menu is selected, Upper Limit in the middle of the screen is highlighted, and an upper frequency limit can be input.
- (3) Menu F3: Lower Limit
Select this menu to set the lower frequency limit value*, using the numeric keypad on the front panel.
When this menu is selected, Lower Limit in the middle of the screen is highlighted, and a lower frequency limit can be input.

*: The upper and lower frequency limits can be set from 0 Hz to Fmax, in 1-Hz steps.

Fmax = 20 GHz (for MF2412C)

27 GHz (for MF2413C)

40 GHz (for MF2414C)

(4) Menu F4: Indicate

Sets whether to display (on) or hide (off) the movement direction indicator (see Figure 4.2.1-3) when the measured frequency value is out of the LCD display range. Set On to display the indicator, and set Off to hide it.

Note:

Judgment result Go/No-Go output is held until the next judgment result is obtained (see Figure 4.3.12-3 below).

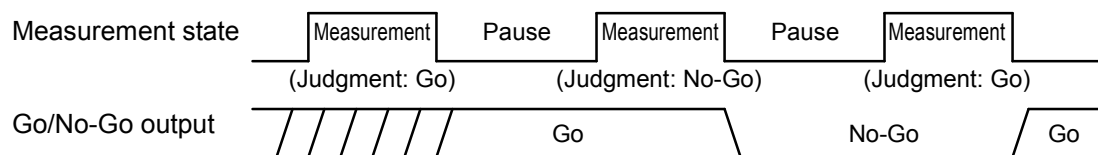

Figure 4.3.12-3 Go/No-Go Judgment Result Output

4.3.13 Hold

This function stops frequency measurement operation and maintains the display of the last measurement value.

Pressing the **Hold** key lights the LED on the key, indicating that the unit is in the hold state. When the **Restart** key is pressed or parameters are set by panel keys at this time, measurement is performed once and then the unit enters the hold state again. In addition, when statistical processing is enabled, the first statistical processing result is calculated and then the unit enters the hold state.

If the **Hold** key is pressed in the hold state, the LED goes off and the unit enters the normal measurement state, resuming the stopped measurement.

4.3.14 Restart

Pressing the **Restart** key restarts the frequency measurement from the first. During statistical processing, the sample measurement execution count is cleared and the statistical processing is started from the first sample.

When the **Restart** key is pressed in the hold state, measurement or statistical processing is performed once and then the unit enters the hold state again.

4.3.15 System

This function performs a variety of tasks such as saving and recalling parameters, selection of a reference signal, selection of a signal to be output from the AUX output connector, setting the GPIB, and checking the self-check results.

Ten parameters from 0 to 9 can be saved.

The external reference signals that can be input are 1 MHz, 2 MHz, 5 MHz, and 10 MHz. When automatic selection of the reference signal is enabled, this function automatically distinguishes these reference signals and uses them as the reference signals for the counter.

Pressing the **Sys** key displays the system setup screen shown in Figure 4.3.15-1.

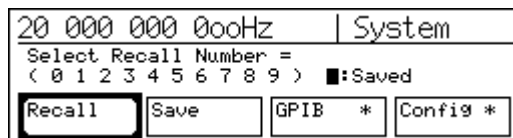

Figure. 4.3.15-1 System Setup Screen

(1) Menu F1: Recall

Sets the saved parameters to this unit.

Select menu F1 using the **←** and **→** keys, and then press the **Enter** key to display the recall number selection screen shown in Figure 4.3.15-2.

On this screen, the numbers for which parameters are saved are highlighted. Use the numeric keypad to input the number to be recalled, and then press the **Enter** key to set the corresponding saved parameters to the unit.

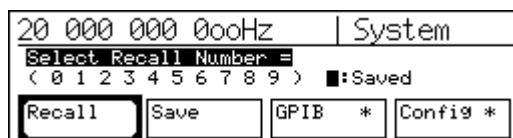

Figure 4.3.15-2 Recall Number Selection Screen

(2) Menu F2: Save

Saves the parameters being executed.

Select menu F2 using the \leftarrow and \rightarrow keys, and then press the **Enter** key to display the save number selection screen shown in Figure 4.3.15-3.

On this screen, the numbers for which parameters are already saved are highlighted. Use the numeric keypad to input a number to be saved, and then press the **Enter** key to save the parameters being executed.

The saved data is cleared after initialization (performed by supplying power while holding down the **Enter** key), but not cleared by pressing the **Preset** key.

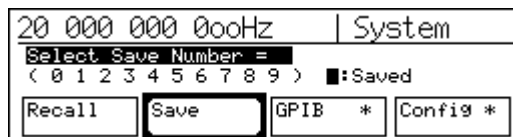

Figure 4.3.15-3 Save Number Selection Screen

(3) Menu F3: GPIB

Select menu F3 using the \leftarrow and \rightarrow keys, and then press the **Enter** key to display the GPIB setup screen shown in Figure 4.3.15-4.

When the **Enter** key is pressed at this time, Address is highlighted, and a GPIB address can be input using the numeric keypad.

The GPIB address can be set from 0 to 30.

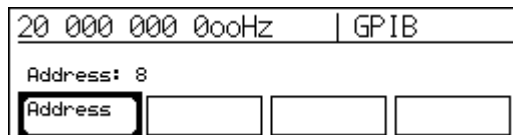

Figure 4.3.15-4 GPIB Setup Screen

(4) Menu F4: Config

Select menu F4 using the \leftarrow and \rightarrow keys, and then press the **Enter** key to display the Config setup screen shown in Figure 4.3.15-5.



Figure 4.3.15-5 Config Setup Screen

(a) Menu F1: Freq Ref

The reference signal selection is changed by pressing the **Enter** key.

When [Int] is selected, only the internal reference signal is used as the reference signal for the counter.

When [Auto] is selected, the reference signal is automatically switched to the external reference signal when a reference signal is externally input.

The set parameter is displayed in brackets of menu F1.

(b) Menu F2: AUX

Selects a signal to be output from the AUX connector.

Select menu F2 using the **←** and **→** keys, and then press the **Enter** key to display the AUX signal selection screen shown in Figure 4.3.15-6. Select **Off**, **Go**, **End**, **Lvl**, **Gate**, **Rest**, or **Acq** using the **←** and **→** keys, and then press the **Enter** key. The Config setup screen (Figure 4.3.15-5) is displayed again, with the set parameter displayed in brackets of menu F2.



Figure 4.3.15-6 AUX Signal Selection Screen

The signals that can be output from the AUX connector and their function are as follows:

- [1] Off: No output
No signal is output. The output level is always high.
- [2] Go: Go/No-Go judgment result output
When the template function is enabled, the judgment result is output.
High: The measured frequency falls within the setting range.
Low: The measured frequency is out of the setting range.
A low level is output when the template function is disabled.
- [3] End: Count End output
A low-level pulse of 1 $\mu\text{s} \pm 50 \text{ ns}$ is output each time frequency measurement is finished.
- [4] Lvl: Level Det output
The detection signal within the counter is monitored during burst measurement.
A high level is output during CW measurement.

- [5] Gate: Internal Count Gate output
The internal gate signal used for counting frequencies is output. A high level is output when the gate is open.
- [6] Rest: Restart output
A low-level pulse of $1\ \mu\text{s} \pm 50\ \text{ns}$ is output each time the Restart command is executed.
- [7] Acq: Acquisition output
A low level is output when the counter is in the acquisition operation.
A high level is output during frequency measurement.

(c) Menu F3: Display

Sets the LCD display intensity (brightness).

Select menu F3 using the \leftarrow and \rightarrow keys, and then press the **Enter** key to display the intensity selection screen shown in Figure 4.3.15-7. Select Off, 25%, 50%, 75%, or 100% using the \leftarrow and \rightarrow keys. When a parameter is selected, the intensity of the LCD display changes accordingly.

Press the **Enter** key to fix the intensity. The Config setup screen (Figure 4.3.15-5) is displayed again, with the set parameter displayed in brackets of menu F3.

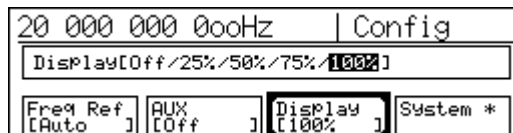

Figure 4.3.15-7 Intensity Selection Screen

Note:

When Off is selected, a measurement screen is displayed with the intensity off, but a setup screen is displayed with the intensity 25%.

(d) Menu F4: System

Select menu F4 using the \leftarrow and \rightarrow keys, and then press the **Enter** key to display the results of the self-check that were executed at power-on, in the format shown in Figure 4.3.15-8.

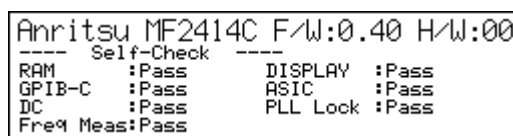

Figure 4.3.15-8 System Screen (Self-Check Result Display Screen)

4.3.16 High-speed sampling function

This function is valid only when the unit is controlled via the GPIB.

The measurement time interval is continuously measured at an arbitrary time interval (T).

This function enables measuring of a fluctuation of frequency in a short time period by obtaining saved data via the GPIB, as well as VCO activation characteristics. Make sure to set the manual frequency and the manual amplitude discrimination value in advance when using Input1 as the signal input connector.

Figure 4.3.16-1 shows the relationships between the parameters for the high-speed sampling function. “T” stands for sample interval and “N” stands for sample count.

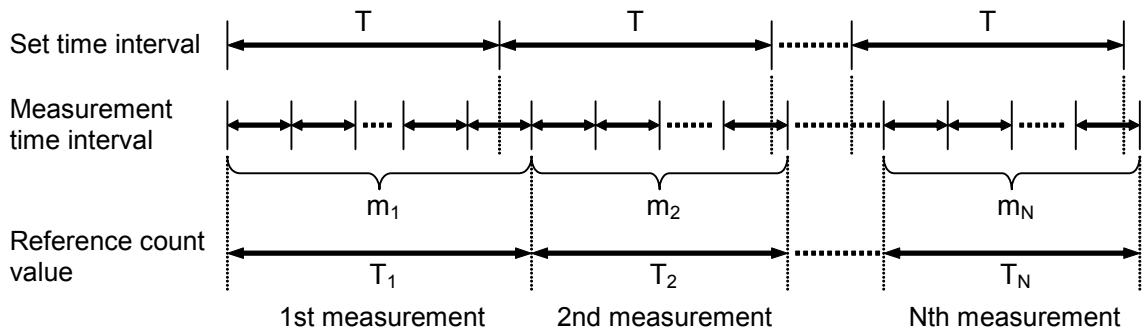

Figure 4.3.16-1 Parameters for High-Speed Sampling Function

The frequency F_i for each measurement can be calculated from the measurement time interval m_i and the reference count value T_i through the following expression : Read out m_i and T_i by device message MTRS (high-speed sample count value).

$$F_i = (m_i/T_i) \times 10^9 \text{ [Hz]} \quad \text{where, } i = 1, 2, 3, \dots, N$$

To multiply the frequency resolution by K, the following combination is used:

$$F_i = \left(\frac{\sum_{p=0}^{K-1} m_{i+p}}{\sum_{p=0}^{K-1} T_{i+p}} \right) \times 10^9 \text{ [Hz]} \quad \text{where, } i = 1, 2, 3, \dots, N - K + 1$$

When using Input2 as the measurement signal input connector, the frequency can be obtained using the expression above. When using Input1, add the offset frequency value F_o to the obtained frequency value F_i . Refer to Section 5 “GPIB” for details on the parameter setting method, the offset frequency value, and high-speed sample count value.

4.3.17 Data storage function

This function is valid only when the unit is controlled via the GPIB.

When a data storage start command is executed, 100 pieces of frequency measurement data are stored in the internal memory. When the 101st piece of data is stored, the first data is invalidated, and the second to 101st data (a total of 100 pieces of data) are valid. A hundred pieces of data stored in the internal memory are updated in this manner, until a data storage stop command is executed.

Stored data can be read by executing a stored data read command.

0 Hz (execution error) is output in the following cases:

- When a stored data read command is executed without executing a data storage stop command after executing a data storage start command
- When a data storage stop command or stored data read command is executed before 100 pieces of data have been stored

Refer to Section 5 “GPIB” for details on the data storage start command, data storage stop command, and stored data read command.

4.4 Measurement

4.4.1 CW frequency measurement via Input1

(Measurement with frequency acquisition = Auto, level acquisition = Auto)

The frequency ranges that can be measured via Input1 are as follows:

MF2412C: 600 MHz to 20 GHz

MF2413C: 600 MHz to 27 GHz

MF2414C: 600 MHz to 40 GHz

(1) Connecting input signal

Connect the signal to be measured to Input1 on the front panel.

Note:



Do not input a signal of +10 dBm or higher into Input1.

(2) Setup

[1] Press the **Preset** key to preset the unit.

Input1, CW measurement, automatic frequency acquisition, and automatic level acquisition are set by preset.

[2] Set the frequency measurement resolution using the  and  keys.

[3] Set the sample rate using the  and  keys.

4.4.2 CW frequency measurement via Input1

(Measurement with frequency acquisition = Manual, level acquisition = Auto)

When the frequency of the input signal is known, manual frequency acquisition measurement can be performed by setting the frequency acquisition mode to Manual and setting a manual frequency value.

Manual frequency acquisition measurement can be started quickly because frequency acquisition is not executed. This measurement is effective when measurement cannot be performed normally due to a spurious signal.

(1) Connecting input signal

Connect the signal to be measured to Input1 on the front panel.

Note:

Do not input a signal of +10 dBm or higher into Input1.

(2) Setup

[1] Press the **Preset** key to preset the unit.

[2] Set the frequency acquisition mode to Manual.

Press the **Freq** key to display the frequency acquisition setup screen, select menu F1 using the **←** and **→** keys, and then press the **Enter** key to set the frequency acquisition mode to Manual.



Figure 4.4.2-1 Frequency Acquisition Setup Screen

[3] Set the manual frequency value.

Select menu F3 using the **←** and **→** keys, and then press the **Enter** key. Manual Freq is highlighted, and a manual frequency value can be input.



Figure 4.4.2-2 Manual Frequency Value Input Screen

This unit measures the set manual frequency value within the input tolerance. If the signal to be measure is not within the input tolerance, it cannot be measured properly.

In the frequency range of 600 MHz to 1 GHz, the manual frequency value ± 30 MHz is valid for the measurement signal.

In the frequency range of 1 GHz or higher, the manual frequency value ± 40 MHz is valid.

- [4] Press the **Return to Meas** key to display the normal measurement screen.
- [5] Set the frequency measurement resolution using the \leftarrow and \rightarrow keys.
- [6] Set the sample rate using the \wedge and \vee keys.

4.4.3 CW frequency measurement via Input1

(Measurement with frequency acquisition = Auto, level acquisition = Manual)

The manual level acquisition measurement can be performed by setting the level acquisition mode to Manual.

Manual level acquisition measurement can be started quickly because level acquisition is not executed. When performing CW measurement with the frequency acquisition mode set to Manual and the level acquisition mode set to Manual, set the frequency acquisition mode to Manual, by referring to Section 4.4.2, and then follow the procedure described in this section.

- (1) Connecting input signal

Connect the signal to be measured to Input1 on the front panel.

Note:

Do not input a signal of +10 dBm or higher into Input1.

- (2) Setup

- [1] Press the **Preset** key to preset the unit.
- [2] Set the level acquisition mode to Manual.
Press the **Level** key to display the level Acquisition setup screen, select menu F1 using the \leftarrow and \rightarrow keys, and then press the **Enter** key to set the level acquisition mode to Manual.

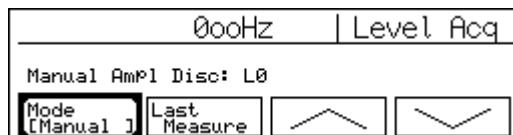

Figure 4.4.3-1 Level Acquisition Setup Screen

- [3] Select the manual amplitude discrimination value using the \leftarrow and \vee keys.

- [4] Press the **Return to Meas** key to display the normal measurement screen.

If the displayed level is not optimum, press the **Level** key and select the manual amplitude discrimination value again so that the optimum level is displayed.



Figure 4.4.3-2 Level Acquisition Measurement Screen

Table 4.4.3-1 Level Indicator

Very low	Slightly low	Optimum	Slightly high	Very high

- [5] Set the frequency measurement resolution using the and keys.
- [6] Set the sample rate using the and keys.

4.4.4 Burst wave measurement via Input1

(Measurement with frequency acquisition = Auto, level acquisition = Auto)

Carrier frequency, pulse width, and pulse repetition period of pulse modulation signals can be measured in the burst measurement mode.

- (1) Connecting input signal

Connect the signal to be measured to Input1 on the front panel.

Notes:

- When automatic frequency acquisition measurement is performed, the pulse modulation width must be at least 1 μ s.
- Do not input a signal of +10 dBm or higher into Input1.

- (2) Setup

- Press the **Preset** key to preset the unit.
- Set the burst measurement mode.
Press the **Meas Mode** key. Check that the Burst LED lights up.
- Set the frequency measurement resolution using the and keys.

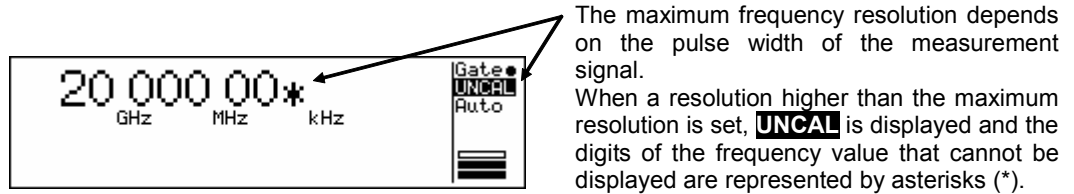

The maximum frequency resolution depends on the pulse width of the measurement signal. When a resolution higher than the maximum resolution is set, **UNCAL** is displayed and the digits of the frequency value that cannot be displayed are represented by asterisks (*).

Figure 4.4.4-1 Burst Carrier Frequency Measurement Screen

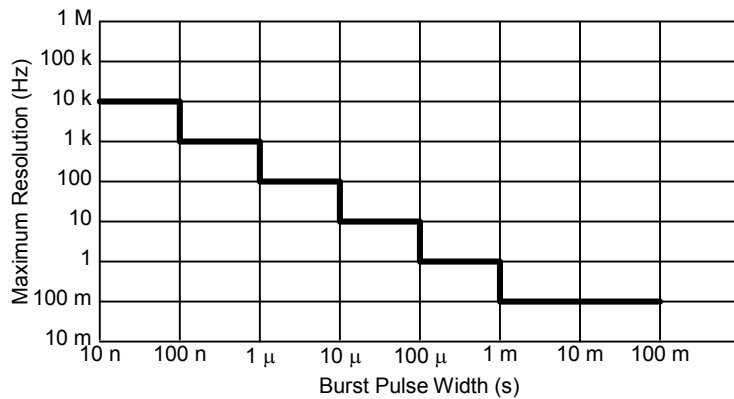

Figure 4.4.4-2 Pulse Width vs. Maximum Frequency Resolution

[4] Set the sample rate using the \square and \square keys.

Notes:

- In automatic frequency acquisition measurement, the pause time may be longer than the set sample rate depending on the pulse width and period of the pulse modulation signal.
- Automatic frequency acquisition measurement may not be performed if the burst wave length (pulse width) is shorter than the period. Perform the measurement in manual frequency acquisition mode in this event.

4.4.5 Burst wave measurement via Input1

(Measurement with frequency acquisition = Manual, level acquisition = Auto)

Carrier frequency, pulse width, and pulse repetition period of pulse modulation signals can be measured in the burst measurement mode.

(1) Connecting input signal

Connect the signal to be measured to Input1 on the front panel.

Note:

Do not input a signal of +10 dBm or higher into Input1.

(2) Setup

[1] Press the **Preset** key to preset the unit.

[2] Set the burst measurement mode.

Press the **Meas Mode** key. Check that the Burst LED lights up.

[3] Set the manual frequency value.

Refer to Section 4.3.6 or 4.4.2 for the setting method. Note that the input tolerance differs between the burst measurement and CW measurement.

(For burst measurement, the input tolerance is ± 30 MHz for the manual frequency range of 600 MHz to 1 GHz, ± 20 MHz for the manual frequency range of 1 GHz or higher in Narrow mode, and ± 40 MHz for the manual frequency range of 1 GHz or higher in Wide mode.)

[4] Set the measurement resolution and sample rate.

Notes:

- Refer to Section 4.4.7 for measuring the pulse width or pulse repetition period at the same time.
- If the frequency is not displayed at all or not displayed properly, set the level acquisition mode to Manual and then perform measurement.
Automatic level acquisition measurement may not be performed if the burst wave length (pulse width) is shorter than the period. In this event also, perform the measurement in manual frequency acquisition mode.

4.4.6 Burst wave measurement via Input1

(Measurement with frequency acquisition = Manual, level acquisition = Manual)

Carrier frequency, pulse width, and pulse repetition period of pulse modulation signals can be measured in the burst measurement mode.

(1) Connecting input signal

Connect the signal to be measured to Input1 on the front panel.

Note:

Do not input a signal of +10 dBm or higher into Input1.

(2) Setup

[1] Press the **Preset** key to preset the unit.

[2] Set the burst measurement mode.

Press the **Meas Mode** key. Check that the Burst LED lights up.

[3] Set the manual frequency value.

Refer to Section 4.3.6 or 4.4.2 for the setting method. Note that the input tolerance differs between the burst measurement and CW measurement.

(For burst measurement, the input tolerance is ± 30 MHz for the manual frequency range of 600 MHz to 1 GHz, ± 20 MHz for the manual frequency range of 1 GHz or higher in Narrow mode, and ± 40 MHz for the manual frequency range of 1 GHz or higher in Wide mode.)

[4] Set the manual amplitude discrimination value, by referring to Section 4.3.5 or 4.4.3.

[5] Set the measurement resolution and sample rate.

Note:

Refer to Section 4.4.7 for measuring the pulse width or pulse repetition period at the same time.

4.4.7 Burst wave pulse width and repetition period measurement via Input1

When the Input1 connector is selected and in the burst measurement mode, either the pulse width or the pulse repetition period of pulse modulation signals can be measured along with the carrier frequency.

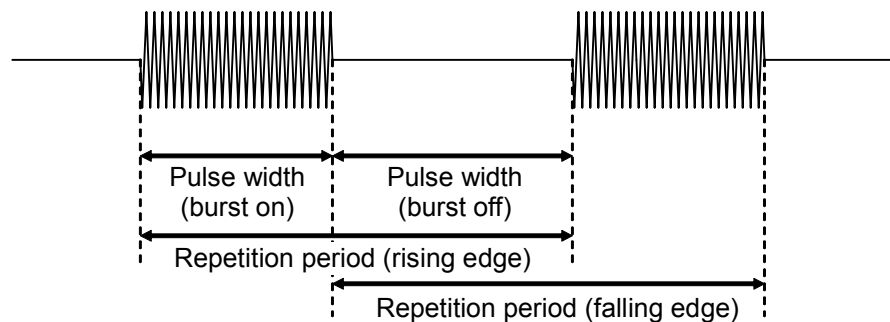

Figure 4.4.7-1 Burst Wave Measurement (Measuring Pulse Width or Repetition Period)

(1) Connecting input signal

Connect the signal to be measured to Input1 on the front panel.

Note:

Do not input a signal of +10 dBm or higher into Input1.

(2) Setup

[1] Press the **Preset** key to preset the unit.

[2] Set the burst measurement mode.

Press the **Meas Mode** key. Check that the Burst LED lights up.

[3] Select the frequency acquisition mode.

It is set to Auto by preset. Refer to Section 4.4.2 for setting Manual.

[4] Select the level acquisition mode.

It is set to Auto by preset. Refer to Section 4.4.3 for setting Manual.

[5] Set the pulse width or pulse repetition period mode.

Press the **Burst** key to display the burst mode selection screen. Select menu F1 using the **←** and **→** keys, and then press the **Enter** key to display the burst mode selection screen.



Figure 4.4.7-2 Burst Mode Selection Screen

Select the measurement mode using the \leftarrow and \rightarrow keys. Select **Width** for measuring the pulse width, and select **Period** for measuring the pulse repetition period. Then press the **Enter** key to fix the selection.

- [6] Select the measurement polarity.
 Select menu F2 using the \leftarrow and \rightarrow keys, and then press the **Enter** key. The polarity changes between positive and negative by pressing the **Enter** key.
 When the negative polarity is selected for pulse width measurement, the pulse width in the burst-off interval is measured. When the negative polarity is selected for pulse repetition period measurement, the period between falling edges is measured.



Figure 4.4.7-3 Burst Measurement Polarity Selection Screen

- [7] Select the burst width, Wide or Narrow.
 Select menu F3 using the \leftarrow and \rightarrow keys, and then press the **Enter** key.
 The burst width changes between Wide and Narrow by pressing the **Enter** key.
 Make sure to set Narrow if the burst pulse width is 1 μ s or shorter. Otherwise, the pulse width cannot be measured properly.



Figure 4.4.7-4 Burst Width Selection Screen

- [8] Press the **Return to Meas** key to display the measurement screen.
 [9] Set the frequency measurement resolution using the \leftarrow and \rightarrow keys.

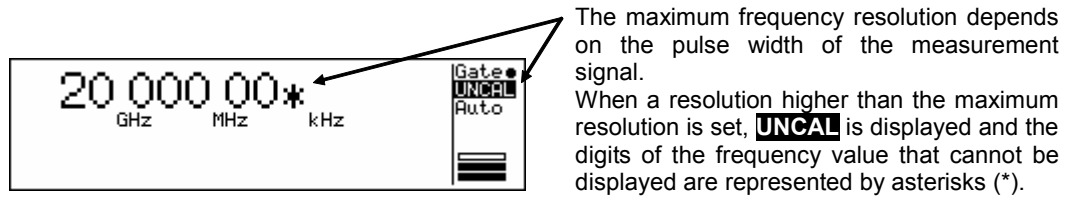

Figure 4.4.7-5 Burst Carrier Frequency Measurement Screen

[10] Set the sample rate using the \square and \square keys.

Note:

If the frequency is not displayed at all or not displayed properly, set both the frequency acquisition mode and the level acquisition mode to Manual and then perform measurement.

Automatic acquisition measurement may not be performed if the burst wave length (pulse width) is shorter than the period. In this event also, perform the measurement in manual acquisition mode.

4.4.8 Burst wave measurement via Input1 using gating function

The frequency at a specific position of a burst signal can be measured using the gating function.

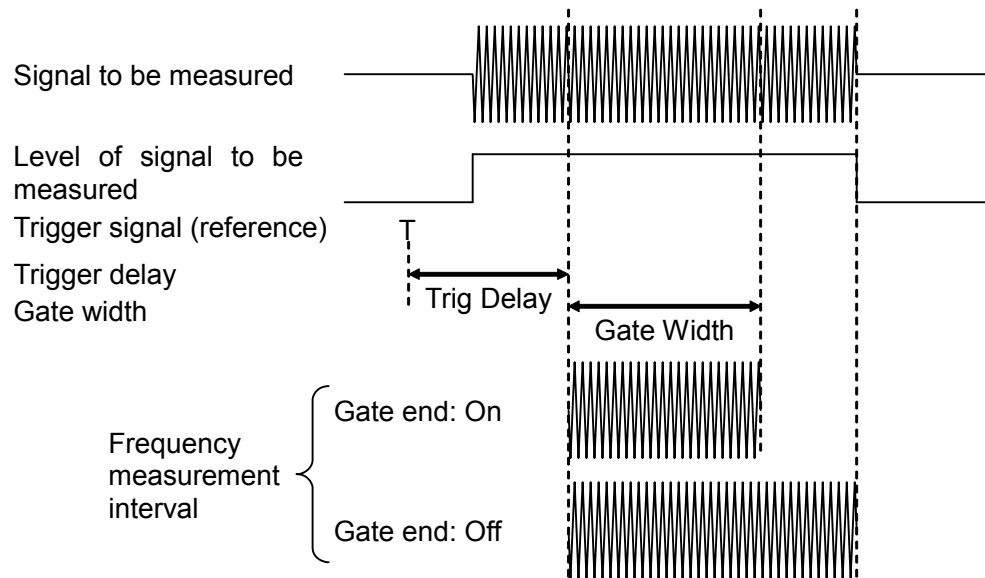

Figure 4.4.8-1 Gating Function Overview

- (1) Connecting input signal

Connect the signal to be measured to Input1 on the front panel.

Note:

Do not input a signal of +10 dBm or higher into Input1.

- (2) Setup

[1] Press the **Preset** key to preset the unit.

[2] Set the burst measurement mode.

Press the **Meas Mode** key. Check that the Burst LED lights up.

[3] Select the frequency acquisition mode.

It is set to Auto by preset. Refer to Section 4.4.2 for setting Manual.

[4] Select the level acquisition mode.

It is set to Auto by preset. Refer to Section 4.4.3 for setting Manual.

- [5] Set the trigger delay.

Press the **TD** key to display the burst monitor screen for trigger delay setting. (This screen can also be displayed by pressing the **◀** or **▶** key from the burst monitor screen for gate width setting.)

When Trig Delay (underscored) is displayed on the lower left of the screen, press the **Enter** key. “Trig Delay” is highlighted, and the numeric value can be changed using the **▲** and **▼** keys. It is also possible to input a numeric value directly using the numeric keypad.

After inputting a value, press the **Enter** key to display Trig Delay (underscored) again.

- [6] Select the measurement polarity.

Select menu F2 using the **◀** and **▶** keys, and then press the **Enter** key.

The polarity changes between positive and negative by pressing the **Enter** key.

When the negative polarity is selected for pulse width measurement, the pulse width in the burst-off interval is measured. When the negative polarity is selected for pulse repetition period measurement, the period between falling edges is measured.

- [7] Set the gate width.

Press the **GW** key to display the burst monitor screen for gate width setting. (This screen can also be displayed by pressing the **◀** or **▶** key from the burst monitor screen for trigger delay setting.)

4.4.9 Frequency measurement via Input2 (10 MHz to 1 GHz)

To measure frequencies from 10 MHz to 1 GHz, select the Input2 connector and an impedance of 50 Ω .

Refer to Section 4.4.10 for measurement of frequencies from 10 Hz to 10 MHz.

(1) Connecting input signal

Connect the signal to be measured to Input2 on the front panel.

Note:

Do not input a signal of 2 Vrms (with 50- Ω impedance)/10 Vrms (with 1-M Ω impedance) or higher into Input2.

(2) Setup

[1] Press the **Preset** key to preset the unit.

[2] Set the input channel to Input2.

Press the **Input** key to display the Input switching screen, and then select menu F1 using the \leftarrow and \rightarrow keys. At this time, Input1 and Input2 are switched by pressing the **Enter** key. Select Input2.

[3] Press the **Return to Meas** key to display the measurement screen.

[4] Set the frequency measurement resolution using the \leftarrow and \rightarrow keys.

[5] Set the sample rate using the \uparrow and \downarrow keys.

4.4.10 Frequency measurement via Input2 (10 Hz to 10 MHz)

To measure frequencies from 10 Hz to 10 MHz, select the Input2 connector and an impedance of 1 M Ω .

Refer to Section 4.4.9 for measurement of frequencies from 10 MHz to 1 GHz.

(1) Connecting input signal

Connect the signal to be measured to Input2 on the front panel.

Note:

Do not input a signal of 2 V_{rms} (with 50- Ω impedance)/10 V_{rms} (with 1-M Ω impedance) or higher into Input2.

(2) Setup

[1] Press the **Preset** key to preset the unit.

[2] Set the input channel to Input2.

Press the **Input** key to display the Input switching screen, and then select menu F1 using the \leftarrow and \rightarrow keys. At this time, Input1 and Input2 are switched by pressing the **Enter** key. Select Input2.

[3] Set the input impedance to 1 M Ω .

Select menu F2 using the \leftarrow and \rightarrow keys. At this time, 50 Ω and 1 M Ω are switched by pressing the **Enter** key. Select 1 M Ω .

[4] Press the **Return to Meas** key to display the measurement screen.

[5] Set the frequency measurement resolution using the \leftarrow and \rightarrow keys.

[6] Set the sample rate using the \uparrow and \downarrow keys.

Section 5 GPIB

This section describes remote operations using the GPIB interface that comes with this unit as standard.

5.1	Overview	5-2
5.2	Function	5-3
5.3	Interface Function	5-5
5.4	Device Message List.....	5-6
5.4.1	Overview.....	5-6
5.4.2	IEEE488.2 common commands.....	5-8
5.4.3	Status registers.....	5-9
5.4.4	Device message list.....	5-12
5.4.5	Compatibility with MF76A Microwave Frequency Counter.....	5-34
5.5	Setting and Checking GPIB	5-36
5.5.1	Connecting GPIB cables	5-36
5.5.2	Setting and checking GPIB address.....	5-37
5.5.3	Recommended GPIB board manufacturers ..	5-37
5.6	Sample Programs	5-38

5.1 Overview

This unit comes with a GPIB interface as standard, enabling automatic measurement by connecting to a host computer. It also makes it possible to measure a fluctuation of frequency in a short time, such as VCO activation characteristics, by using the high-speed sampling function achieved through data processing by the host computer.

5.2 Function

This unit offers the following functions by using the GPIB.

Table 5.2-1 Available Functions and Corresponding Device Messages

Function	Device Message
Input: Switching of measurement signal input channels Switching of Input2 attenuator Switching of Input2 input impedance Setting of manual frequency Switching of frequency acquisition mode Switching of level acquisition mode Setting of Input1 amplitude discrimination value (attenuator)	INPCH ATTN INP2Z AF ACF ACL AD
Reference signal: Selection of reference signal	REF
Measurement: Switching of count mode Selection of measurement start/stop Setting of frequency resolution Setting of sample rate	CNTMD SH RES SMP
Burst signal: Switching of burst measurement on/off Selection of burst signal measurement mode Switching of burst signal polarity Switching of burst signal measurement width	BST BSTMD BSTPL BSTWDT
Gating: Switching of gate end on/off Setting of gate width	GTEND GTWDT
Trigger: Switching of trigger source Setting of trigger delay Selection of trigger polarity	TRG TRGDLY TRGPL
Template: Switching of template function on/off Switching of movement direction indicator on/off Setting of template lower frequency limit Setting of template upper frequency limit	LMT LMTDIR LMTL LMPU

Table 5.2-1 Available Functions and Corresponding Device Messages (Cont'd)

Function	Device Message
Data output: Switching of data output format and timing	OM
Reading of measured results: Carrier frequency of burst signal Burst width Repetition period of burst signal Frequency of CW signal Offset frequency Statistical processing value High-speed sampling count	MBCF MBWDT MBPRD MCW MOFS MSTA MTRS
Offset value calculation processing: Selection of offset function Selection of offset value setting method Setting of offset frequency value	OFS OFSDT OFSFRQ
Statistical processing: Selection of statistical processing function Selection of sample data extraction method Setting of sample count	STS STSBLK STSMPL
High-speed sampling function: Switching of High-speed sampling mode on/off Setting of sample count Setting of sampling period Reading of offset frequency	TRS TRSSMP TRSRT TRSOFS
Data storage function: Data storage start Data storage stop Stored data read	DSTA DSTP MDS
GPIB: Selection of terminator End status register Error status register	TRM ESE2, ESR2 ESE3, ESR3
Display: Setting of display brightness	DSPL
Others: Selection of signal output to AUX connector Switching to measurement screen	AUX RTM

5.3 Interface Function

This unit provides the GPIB interface functions listed in Table 5.3-1.

Table 5.3-1 Interface Functions

Code	Interface Function
SH1	Full source handshake
AH1	Full acceptor handshake
T6	Basic talker Serial poll Talk only Talk release using MLA
L4	Basic listener No listen only Listen release using MTA
SR1	Full service request and status byte
RL1	Full remote/local
PP0	No parallel poll
DC1	Full device clear
DT1	Full device trigger
C0	No controller function

5.4 Device Message List

5.4.1 Overview

Device messages refer to data messages that are transmitted and received between a controller and device (this unit in this case) via the GPIB interface. There are two types of device messages: program messages and response messages. In addition, these messages consist of common commands conforming to the IEEE 488.2 standard and messages unique to this unit. Refer to Section 5.4.2 “IEEE 488.2 common commands” for the common commands, and Section 5.4.4 “Device message list” for the messages unique to this unit.

(1) Program messages

ASCII data messages transmitted from the controller to the device. They are divided into commands and queries.

[1] Commands: Used to set parameters and instruct the starting of measurement for the device.

[2] Queries: Used to inquire device states for the device and obtain measurement data from the device.

(2) Response messages

ASCII data messages transmitted from the device to the controller. They transfer device states and measurement data to the controller.

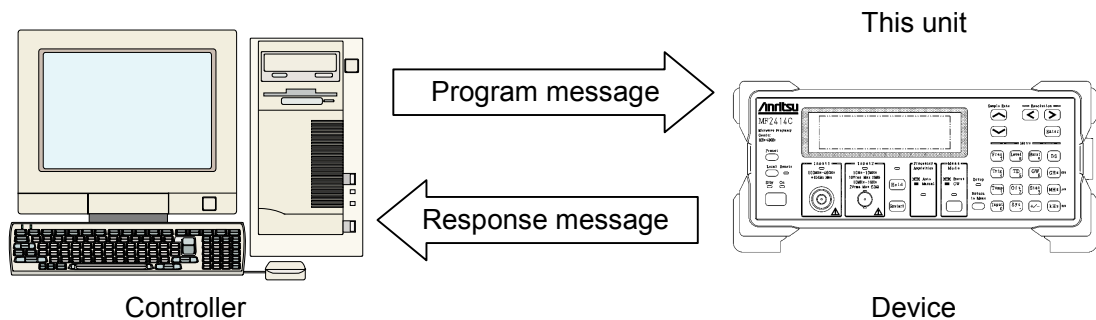

Figure 5.4.1-1 Device Messages

When using device messages to transmit and receive numeric data such as frequencies, a unit (suffix code) can be attached to the numeric data to be transferred. For example, when setting 1 MHz for the frequency data, attach a suffix code and send 1000000 HZ, 1000 KHZ, or 1 MHZ, instead of transmitting 1000000.

The following shows the suffix codes that can be used with this unit:

(1) Suffix codes when transferring frequency data

Unit	Suffix Code*
GHz	GHZ, G
MHz	MHZ, MA
kHz	KHZ, K
Hz	HZ, omitted

*: All suffix codes are recognized as uppercase even if entered in lower case.

Note:

Millihertz (mHz) is not supported.

(2) Suffix codes when transferring time data

Unit	Suffix Code*
Second	S
Millisecond	MS, M
Microsecond	US, U
Nanosecond	NS, N, omitted

*: All suffix codes are recognized as uppercase even if entered in lower case.

5.4.2 IEEE488.2 common commands

Table 5.4.2-1 lists the commands that can be used with this unit, from among 39 common commands defined in the IEEE488.2 standard.

Table 5.4.2-1 Common Commands

Name	Description
*IDN?	Returns MF24xxC, ANRITSU, 0, n. xx: 12 = MF2412C, 13 = MF2413C, 14 = MF2414C n: Firmware version number
*RST	Presets the unit (same function as the Preset key).
*TST?	Returns the value n in which the corresponding bits of the following ones are set if an error occurs as a result of a self-check. bit 0 (LSB): CPU, bit 1: EXT-RAM, bit 2: GPIB, bit 3: LCD, bit 4: ASIC, bit 5: +12 V, bit 6: +15 V, bit 7: -15 V, bit 8: -5 V, bit 9: PLL1, bit 10: PLL2, bit 11: Frequency Measure, bit 12: +5 V, bit 13: +3.3 V, bit 14: +7 V
*OPC	Sets bit 0 of the standard event status register (SESR) when the previous command ends. If bit 0 of the standard event status enable register (SESER) is set at that time, SRQ is generated.
*OPC?	Returns 1 when the previous command execution ends. Nothing is returned until the previous command execution ends.
*WAI	The next command is not executed until the previous command execution ends.
*CLS	Executes the clear function defined in the IEEE488.2 standard.
*ESE n	Sets the value of the standard event status enable register (SESER) (0 to 255).
*ESE?	Returns the value of the standard event status enable register (SESER) (0 to 255).
*ESR?	Returns the value of the standard event status register (SESR) (0 to 255).
*SRE n	Sets the value of the service request enable register (SRER) (0 to 255).
*SRE?	Returns the value of the service request enable register (SRER) (0 to 255).
*STB?	Returns the value of the status byte register (0 to 255).
*TRG	Execute the same function as that of the group execute trigger.
*RCL n	Recalls the device state saved in the specified memory (0 to 9).
*SAV n	Saves the current device state in the specified memory (0 to 9).

5.4.3 Status registers

Figure 5.4.3-1 shows the configuration of the status registers.

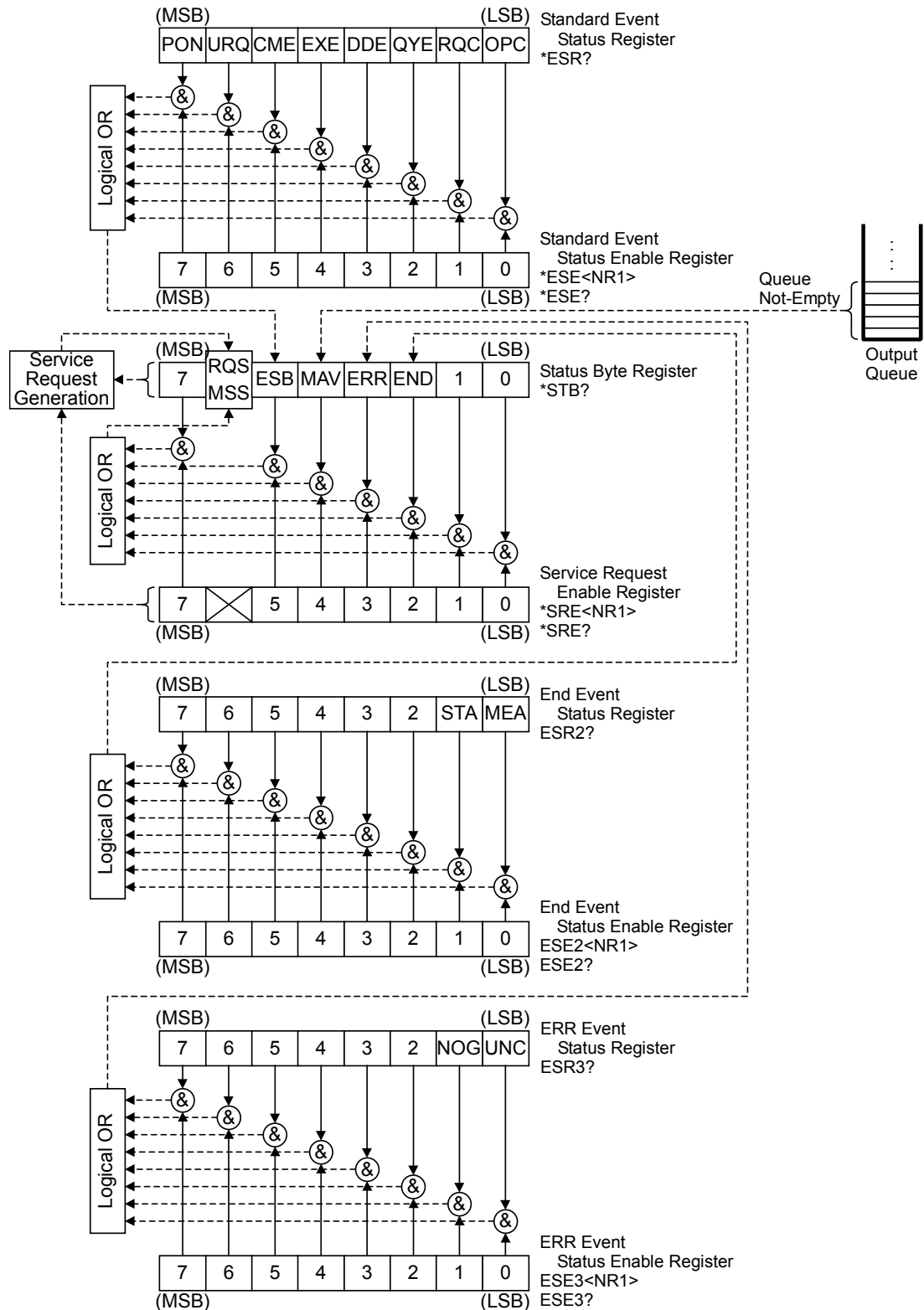

Figure 5.4.3-1 Configuration of Status Registers

(1) Standard Event Status Register

The function and setting condition of each bit are described in Table 5.4.3-1.

Table 5.4.3-1 Standard Event Status Register

Bit	Function	Setting Condition
PON	Power on	When power is turned on (power off → power on).
URQ	User request	When a user request is generated (not used and always 0).
CME	Command error	When the format of a received message cannot be interpreted, a message having an unsupported header is received, or GET is detected while receiving a program message.
EXE	Execution error	When the program data following the header is out of the normal range, or the program message cannot be processed due to a previously set value.
DDE	Device dependent error	When a device-unique error has occurred (not used and always 0).
QYE	Query error	A read request is issued when the output queue is empty, or the output queue data is lost.
RQC	Request control	When the controller function is requested (not used and always 0).
OPC	Operation complete	When all the specified operations are completed in response to *OPC.

(2) Standard Event Status Enable Register

This register allows events of the standard event status register to be reflected to the ESB bit of the status byte register.

(3) Status Byte Register

The function and setting condition of each bit are described in Table 5.4.3-2.

Table 5.4.3-2 Status Byte Register

Bit	Function	Setting Condition
MSS	Master summary status	When an event concerning END, ERR, MAV, or ESB occurs.
RQS	Request service	When a service request concerning END, ERR, MAV, or ESB occurs.
ESB	Event status	When at least one event allowed by the standard event status enable register occurs.
MAV	Message available	When the output queue has data.
ERR	Error event status	When at least one event allowed by the ERR event status enable register occurs.
END	End event status	When at least one event allowed by the END event status enable register occurs.
–	Other bits	The other bits are undefined and always 0.

(4) Service Request Enable Register

This register allows service requests.

(5) END Event Status Register

The function and setting condition of each bit are described in Table 5.4.3-3.

Table 5.4.3-3 END Event Status Register

Bit	Function	Setting Condition
MEA	End of measurement	When the specified measurement ends
STA	End of statistical processing	When the specified statistical processing ends
–	Other bits	The other bits are undefined and always 0.

(6) END Event Status Enable Register

This register allows events of the END event status register to be reflected to the END bit of the status byte register.

(7) ERR Event Status Register

The function and setting condition of each bit are described in Table 5.4.3-4.

Table 5.4.3-4 ERR Event Status Register

Bit	Function	Setting Condition
UNC	Uncal error	When the measurement result is UNCAL.
NOG	No-Go judgment	When the template function valid and the judgment result is No-Go.
–	Other bits	The other bits are undefined and always 0.

(8) ERR Event Status Enable Register

This register allows events of the ERR event status register to be reflected to the ERR bit of the status byte register.

5.4.4 Device message list

(1) A

- [1] ACF frequency acquisition
Sets whether to acquire the frequency manually or automatically. Also sets whether to use the measured frequency value or the frequency value set by the manual frequency setting command AF for the measurement target frequency value (manual frequency) in manual frequency acquisition mode.

Command: ACF n(s)
Query: ACF?
Response: ACF n

<Program data>

Value of n Set value
0 AUTO (Initial value)
1 MANUAL

Value of s
0 Measures at the frequency set by the command AF (Default value).
1 Measures at the frequency measured previously (AF setting value is overwritten).

- [2] ACL level acquisition
Sets whether to acquire the level manually or automatically. Also sets whether to use the current set value or the value set in advance by the amplitude discrimination value setting command AD for the amplitude discrimination value in manual level acquisition mode.

Command: ACL n(s)
Query: ACL?
Response: ACL n

<Program data>

Value of n Set value
0 AUTO (Initial value)
1 MANUAL

Value of s
0 Measures at the level set by the command AD (Default value).
1 Measures at the level measured previously (AD setting value is overwritten).

- [3] AD manual amplitude discrimination
Sets the value of the attenuator inside Input1 used as the amplitude discrimination value.

Command: AD n

Query: AD?

Response: AD n

<Program data>

Value of n	Set value
0	42 dB (Initial value)
1	36 dB
2	30 dB
3	24 dB
4	18 dB
5	12 dB
6	6 dB
7	0 dB

Note:

0 dB is set if n is set to 7 or greater.

- [4] AF frequency for manual acquisition
Sets the frequency to be set for manual frequency acquisition in advance.

Command: AF n

Query: AF?

Response: AF n

<Program data>

Value of n

For MF2412C: 600×10^6 to 20×10^9 Hz

For MF2413C: 600×10^6 to 27×10^9 Hz

For MF2414C: 600×10^6 to 40×10^9 Hz

Suffix code: GHZ, MHZ, KHZ, HZ, G, MA, K

The setting resolution is 1 MHz. The digits lower than MHz are rounded off.

[5] ATTN input2 attenuator
Sets the input attenuator to be inserted into the system with Input2 and 1 M Ω .

Command: ATTN n
Query: ATTN?
Response: ATTN n

<Program data>

Value of n Set value
 0 ATT Through
 1 20 dB ATT On (Initial value)

[6] AUX auxiliary output
Select the signal to be output from the AUX connector on the rear panel.

Command: AUX n
Query: AUX?
Response: AUX n

<Program data>

Value of n Set value
 0 Off (Initial value)
 1 Go/NoGo
 2 Count End
 3 Level Det
 4 Int Gate
 5 Restart
 6 Acquisition

Off: Always outputs a high level when the template function is disabled.

Go/NoGo: Outputs the template function judgment result.
 Outputs a high level when the measured frequency falls within the setting range.
 Outputs a low level when the measured frequency is out of the setting range.

Count End: Outputs a low-level pulse each time frequency measurement ends.

Level Det: Outputs the detection signal within the counter during burst signal measurement.

Int Gate: Outputs the internal gate signal used for frequency counting.
 Outputs a high level when the gate is open.

Restart: Outputs a low-level pulse when the Restart command is executed.
 Acquisition: Outputs a low level during acquisition operation.

(2) **B**

[1] **BST** burst measurement
 Specifies whether to perform burst measurement or CW measurement.

Command: BST n
 Query: BST?
 Response: BST n

<Program data>

Value of n Set value
 0 Burst off: CW measurement (Initial value)
 1 Burst on: Burst measurement

[2] **BSTMD** burst mode
 Specifies whether to measure carrier frequency, burst width, or burst repetition period during burst measurement.

Command: BSTMD n
 Query: BSTMD?
 Response: BSTMD n

<Program data>

Value of n Set value
 0 Carrier frequency (Initial value)
 1 Burst width
 2 Burst period

Table 5.4.4-1 Relationship between Burst Measurement Target and Burst Measurement Polarity

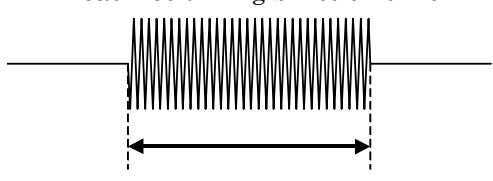
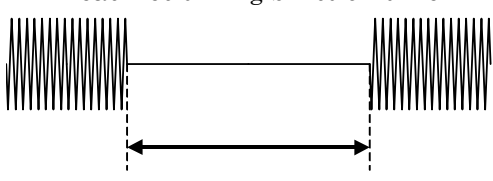
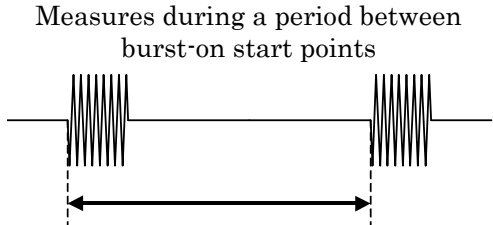
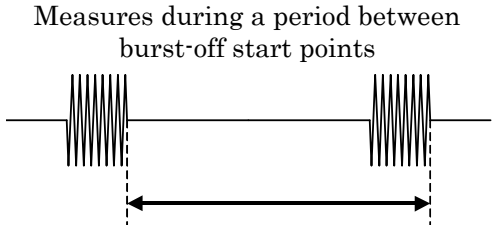
		Burst Measurement Polarity	
		Positive	Negative
Measurement Item	Burst Width	Measures during burst-on time 	Measures during burst-off time 
	Burst Period	Measures during a period between burst-on start points 	Measures during a period between burst-off start points 

[3] BSTPL burst polarity
Sets the position (see “[2] BSTMD”) as follows when measuring burst width or burst period.

Command: BSTPL n

Query: BSTPL?

Response: BSTPL n

<Program data>

Value of n Set value

0 Positive (Initial value)

1 Negative

[4] BSTWDT burst width

Sets the burst width to be measured.

Command: BSTWDT n

Query: BSTWDT?

Response: BSTWDT n

<Program data>

Value of n Set value

0 Wide (Initial value, Burst width: 1 μ s to 0.1 s)

1 Narrow (Burst width: 100 ns to 0.1 s)

Note that the carrier frequency must be at least 600 MHz for Wide, and at least 1 GHz for Narrow.

(3) C

[1] CNTMD count mode

Sets the Input1 count method to Fast (reciprocal) or Normal (direct count).

Command: CNTMD n

Query: CNTMD?

Response: CNTMD n

<Program data>

Value of n	Set value
0	Fast (Initial value)
1	Normal

(4) D

[1] DSPL display intensity

Sets the intensity (brightness) of the LCD.

Command: DSPL n

Query: DSPL?

Response: DSPL n

<Program data>

Value of n	Set value
0	Off*
1	25%
2	50%
3	75%
4	100%

*: When Off is selected, a measurement screen is displayed with the intensity off, but a setup screen is displayed with the intensity 25%.

[2] DSTA data storage start

Starts the data storage function that traces the measured frequency values into the internal memory.

Command: DSTA

[3] DSTP data storage stop

Stops the data storage function, enabling traced data to be loaded.

Command: DSTP

Note:

Make sure to executed DSTP after the measured frequency values have been traced into the internal memory by using *WAI or *OPC?.

Normal frequency measurement values may not be obtained if DSTP is executed during date saving.

(5) **E**

- [1] ESE2 End Event Status Enable Register
Sets each bit of the END event status enable register, which is a GPIB status enable register.

Command: ESE2 n

Query: ESE2?

Response: ESE2 n

<Program data>

Value of n Set value

0 to 255.... Refer to Section 5.4.3 "Status Registers."
(Initial value: 0)

- [2] ESE3 ERR Event Status Enable Register
Sets each bit of the ERR event status enable register, which is a GPIB status enable register.

Command: ESE3 n

Query: ESE3?

Response: ESE3 n

<Program data>

Value of n Set value

0 to 255.... Refer to Section 5.4.3 "Status Registers."
(Initial value: 0)

- [3] ESR2 End Event Status Register
Returns the value of the END event status register, which is a GPIB status register.

Query: ESR2?

Response: n

<Response data>

Refer to Section 5.4.3 "Status registers."

- [4] ESR3 ERR Event Status Register
Returns the value of the ERR event status register, which is a GPIB status register
Query: ESR3?
Response: n
<Response data>
Refer to Section 5.4.3 “Status registers.”

(6) G

- [1] GTEND gate end
Sets whether the carrier frequency measurement range is to be extended to the end of the gate width or to the end of the burst.
Command: GTEND n
Query: GTEND?
Response: GTEND n
<Program data>
Value of n Set value
 0 End of burst (Initial value)
 1 End of gate width
Note that when the burst ends before the end of the gate width, the measurement ends at the end of the burst.
- [2] GTWDT gate width
Sets the gate width.
Command: GTWDT n
Query: GTWDT?
Response: GTWDT n
<Program data>
Value of n
 100×10^{-9} to 100×10^{-3}
Suffix code: NS, US, MS, S, N, U, M
Make sure to set the value n in 20-ns steps for the range from 100 ns to 1 μ s, and in two significant digits for the range from 1 μ s to 100 ms. Values exceeding these ranges will be rounded off.

(7) I

- [1] INPCH input channel
Select the connector to input signals.

Command: INPCH n
Query: INPCH?
Response: INPCH n

<Program data>

Value of n Set value
 1 Input1 (Initial value)
 2 Input2

- [2] INP2Z ch2 input impedance
Switches the input impedance of the Input2 connector.

Command: INP2Z n
Query: INP2Z?
Response: INP2Z n

<Program data>

Value of n Set value
 0 50 Ω (Initial value)
 1 1 M Ω

(8) L

- [1] LMT limit on/off (template function)
Sets whether to enable or disable the template function.

Command: LMT n
Query: LMT?
Response: LMT n

<Program data>

Value of n Set value
 0 Template function off (Initial value)
 1 Template function on

- [2] LMTDIR limit direction indicator
Sets whether to display or hide the indicator, which is used to indicate the movement (change) direction of the measurement frequencies (i.e., closing to the frequency range on the analog display screen or departing from it) when the measured frequency value greatly exceeds the frequency range defined by the upper and lower limits.

Command: LMTDIR n
Query: LMTDIR?
Response: LMTDIR n

<Program data>

Value of n Set value
 0 Indicator off (Initial value)
 1 Indicator on

- [3] LMTL lower limit
 Sets the lower frequency limit for the template function.

Command: LMTL n
 Query: LMTL?
 Response: LMTL n

<Program data>

Value of n
 10 to Fmax*
 Suffix code: GHZ, MHZ, KHZ, HZ, G, MA, K
 *: Fmax = 20 GHz (for MF2412C)
 27 GHz (for MF2413C)
 40 GHz (for MF2414C)

- [4] LMTU upper limit
 Sets the upper frequency limit for the template function.

Command: LMTU n
 Query: LMTU?
 Response: LMTU n

<Program data>

Value of n
 10 to Fmax*
 Suffix code: GHZ, MHZ, KHZ, HZ, G, MA, K
 *: Fmax = 20 GHz (for MF2412C)
 27 GHz (for MF2413C)
 40 GHz (for MF2414C)

(9) M

- [1] MBCF measurement data (burst carrier frequency)
 Outputs the burst carrier frequency during burst measurement.
 This is a measurement result read function.

Query: MBCF?
 Response: n

<Response data>

Value of n
 Outputs in frequency units (Hz).
 "0HZ" is returned during CW measurement (burst off).

- [2] MBWDT measurement data (burst width)
Outputs the burst width during burst measurement. This is a measurement result read function.
Query: MBWDT?
Response: n
<Response data>
Value of n
 Outputs in time units (NS).
 “0NS” is returned during CW measurement (burst off).
- [3] MBPRD measurement data (burst period)
Outputs the burst repetition period during burst measurement. This is a measurement result read function.
Query: MBPRD?
Response: n
<Response data>
Value of n
 Outputs in time units (NS).
 “0NS” is returned during CW measurement (burst off).
- [4] MCW measurement data (continuous wave)
Outputs the measured frequency value during CW measurement. This is a measurement result read function.
Query: MCW?
Response: n
<Response data>
Value of n
 Outputs in frequency units (Hz).
 “0HZ” is returned during burst measurement (burst on).
- [5] MOFS measurement data (offset frequency)
Outputs the +/-offset calculation result and the ppm calculation result. This is a measurement result read function.
Query: MOFS?
Response: n
<Response data>
Value of n
 - Outputs in frequency units (HZ) when the offset mode is set to +Offset or -Offset.
 - Outputs in deviation units (ppm) when the offset mode is set to ppm.
 - “0HZ” is returned when the offset mode is set to Off.

[6] MSTA measurement data (frequency from the statistic point of view)

Outputs statistical processing results for mean, p-p, min, and max.

Query: MSTA?

Response: n1,(n2)

<Response data>

- Uses n1 for mean or p-p.
Value of n1: Outputs in frequency units (HZ).
- Uses n1 and n2 for max.
Value of n1: Outputs in max frequency units (HZ).
Value of n2: Outputs in min frequency units (HZ).
- Uses n1 and n2 for min.
Value of n1: Outputs in min frequency units (HZ).
Value of n2: Outputs in max frequency units (HZ).
- "0HZ" is returned when the statistical processing is off.

[7] MTRS measurement data (transient frequency)

Reads the result obtained by the high-speed sampling function. It uses this result to calculate the deviation (Δf_i) from the offset frequency (f_0), and then calculate the input frequency (X_{f_i}) by adding the deviation to the offset frequency.

Query: MTRS? n

Response: T1,m1
T2,m2
:
Tn,mn

<Program data>

Value of n:

100, 200, 500, 1000, 2000

<Response data>

Reads n group data in the combination of T_i and m_i ($i = 1$ to n). Using the result, the frequency f_i for each measurement time i is calculated from the following expression:

$$\Delta f_i = (m_i/T_i) \times 10^9 \text{ [Hz]} \quad \text{where, } i = 1, 2, 3, \dots, n$$

To multiply the frequency resolution by k , the following combination is used:

$$\Delta f_i = \left(\frac{\sum_{p=0}^{k-1} m_{i+p}}{\sum_{p=0}^{k-1} T_{i+p}} \right) \times 10^9 \text{ [Hz]} \quad \text{where, } i = 1, 2, 3, \dots, n - k + 1$$

The offset frequency f_0 is output by the query message TRSOFS?. The input frequency X_{fi} is calculated by the following expression:

$$X_{fi} = \text{abs}(f_0) + \Delta f_i \text{ (when } f_0 \geq 0)$$

$$X_{fi} = \text{abs}(f_0) - \Delta f_i \text{ (when } f_0 < 0)$$

Note that $\text{abs}(f_0)$ is the absolute value of f_0 .

- [8] MDS measurement data (frequency from the data storage memory)

Reads data traced in the internal memory.

100 pieces of data are output from the oldest one (r1).

Query: MDS?

Response: r1
 r2
 :
 r100

Note:

“0HZ” is returned as response data when data cannot be read out.

(10) O

- [1] OFS offset

Adds or subtracts the previously set offset value to/from the measured frequency result, or calculate the deviation.

Command: OFS n,(s)

Query: OFS?

Response: OFS n

<Program data>

Value of n	Set value
0	Offset (Initial value)
1	+Offset
2	-Offset
3	ppm

Value of s	Value set
0	The value set by the command OFSFRQ is used as the offset value (Default value).
1	The previously measured value is used as the offset value (the value set by the command OFSFRQ is overwritten.)

- [2] OFSDT offset data
 Selects whether to set the offset value update mode on or off.
 When the update mode is set to on, the previously measured
 value is successively updated as the offset value.

Command: OFSDT n

Query: OFSDT?

Response: OFSDT n

<Program data>

Value of n Set value

 0 Update mode off (Initial value)

 1 Update mode on

- [3] OFSFRQ offset frequency
 Sets the offset frequency value.

Command: OFSFRQ n

Query: OFSFRQ?

Response: OFSFRQ n

<Program data>

Value of n

 0 to Fmax*

Suffix code: GHZ, MHZ, KHZ, HZ, G, MA, K

*: Fmax = 20 GHz (for MF2412C)

 27 GHz (for MF2413C)

 40 GHz (for MF2414C)

- [4] OM output mode
 Sets the unit to the continuous output mode for numeric output
 format data used by the MF76A Microwave Frequency Counter.
 The host CPU can continuously read the measurement data
 when an Input statement (specify this unit as the talker) after
 the following command message.

Command: OM n

Query: OM?

Response: OM 2

<Program data>

Value of n Set content

 0 The unit is specified as the talker by the Input
 statement of the host CPU. The measured
 result immediately after a data output request is
 output (initial value).

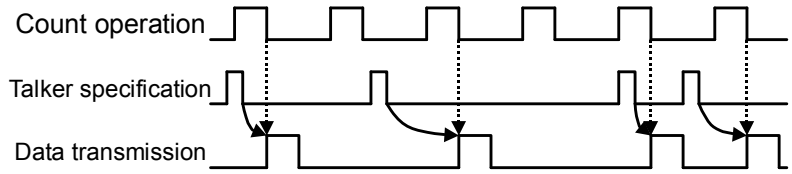

Figure 5.4.4-1 Data Transmission Timing When OM 0 Is Set

- 1 The unit is specified as the talker by the Input statement of the host CPU, and the data output request generation timing and the frequency measurement timing are synchronized. The next measurement does not start until the measured result is output.

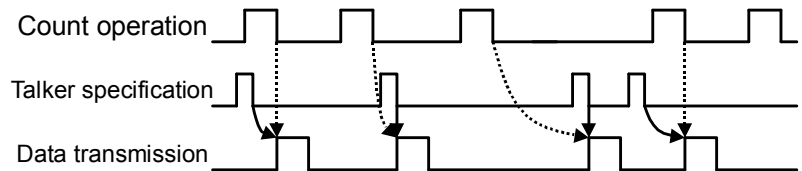

Figure 5.4.4-2 Data Transmission Timing When OM 1 Is Set

- 2 Sets the IEEE488.2 communication format.

Note:

The OM mode is automatically set to 2 when a program message is transmitted with OM = 0 and OM = 1.

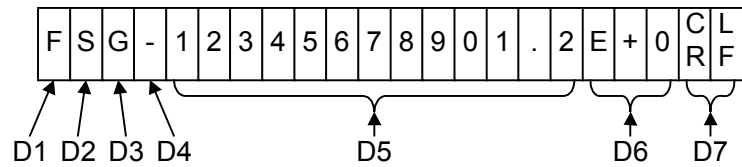

Figure 5.4.4-3 Numeric Value Output Format

D1: Indicates the data type.

- F: Frequency (Unit: Hz)
- R: Parts per million (Unit: ppm)
- W: Pulse width (Unit: second)
- P: Pulse repetition period (Unit: second)

D2: Indicates whether the offset calculation is performed.

- S: Offset on
- Blank: Offset off

D3: Indicates whether the invalid display of read values, specification judgment result, or statistical processing is performed.

- | | | |
|--------|---------------------|----------|
| | | Priority |
| U: | UNCAL | High |
| L: | No-Go (lower side) | } ↑ |
| H: | No-Go (higher side) | |
| G: | Go | |
| M: | Mean value | } ↓ |
| X: | Maximum value | |
| N: | Minimum value | |
| P: | p-p | |
| Blank: | The above is off | Low |

When there are two or more conditions, the one having the highest priority is applied.

D4: Indicates the sign of the data.

- : When the data sign is -.
- Blank: When the data sign is +.

D5: Indicates twelve-digit data consisting of a numeric value and a floating point.

D6: Indicates the exponent for numeric data.

$$E+0 = 10^0, E+3 = 10^3, E+6 = 10^6, E+9 = 10^9$$

D7: Indicates the terminator.

- LF^EOI: TRM0 (Initial value)
- CR LF^EOI: TRM1

(11) **R**

- [1] REF reference frequency
Selects whether to use only the internal signal or to enable automatic switching for the reference signal.

Command: REF n
Query: REF?
Response: REF n

<Program data>

Value of n	Set value
0	Auto (Initial value)
1	Internal

- [2] RES frequency resolution
Sets the frequency measurement resolution.

Command: RES n
Query: RES?
Response: RES n

<Program data>

Value of n	Set value
0	1 mHz
1	10 mHz
2	100 mHz
3	1 kHz
4	10 kHz
5	100 Hz (Initial value)
6	1 kHz
7	10 kHz
8	100 kHz
9	1 MHz

- [3] RTM return to measure
Displays the measurement screen.

Command: RTM

(12) S

- [1] SH sampling hold
Starts or stops frequency measurement.

Command: SH n

Query: SH?

Response: SH n

<Program data>

Value of n Set value

0 Sampling (Initial value)

1 Hold

Note:

When the unit is in the hold state (SH 1), frequency measurement can be restarted by executing *TRG or GET (address command).

- [2] SMP sampling rate
Sets the sample rate (pause time).

Command: SMP n

Query: SMP?

Response: SMP n

<Program data>

Value of n Set value

0 1 ms

1 2 ms

2 5 ms

3 10 ms

4 20 ms

5 50 ms

6 100 ms (Initial value)

7 200 ms

8 500 ms

9 1 s

10 2 s

11 5 s

12 10 s

- [3] STS statistic function
Selects the statistical processing.
Command: STS n
Query: STS?
Response: STS n

<Program data>

- Value of n Set value
- 0 Off (Initial value)
- 1 mean
- 2 max
- 3 min
- 4 p-p

- [4] STSBLK statistic sample extraction
Sets whether to perform overlap processing for statistical processing.
Command: STSBLK n
Query: STSBLK?
Response: STSBLK n

<Program data>

- Value of n Set value
- 0 Discrete block sequence (Initial value)
- 1 Overlap block sequence

- [5] STSMPL statistic sample point
Sets the sample count used for statistical processing to 10 to the n-th power (STSBLK = 0, discrete mode) or to 2 to the n-th power (STSBLK = 1, overlap mode).
Command: STSMPL n
Query: STSMPL?
Response: STSMPL n

<Program data>

- Value of n
- 1 to 6 (Initial value: 1)

The sample count is 10^n when STSBLK = 0, and is 2^n when STSBLK = 1.

Note:

See Table 4.3.11-1 for details on the sample count.

(13) T

[1] TRG trigger mode

Selects the trigger source.

Command: TRG n

Query: TRG?

Response: TRG n

<Program data>

Value of n Set value

0 Internal (Initial value)

1 External

2 Line (AC)

[2] TRGDLY trigger delay

Sets the trigger delay value.

Command: TRGDLY n

Query: TRGDLY?

Response: TRGDLY n

<Program data>

Value of n

0,

20×10^{-9} to 100×10^{-3} (sec)

Suffix code: NS, US, MS, S, N, U, M

Make sure to set the value n in 20-ns steps for the range from 20 ns to 320 ns, in 40-ns steps for the range from 320 ns to 1 μ s, and in two significant digits for the range from 1 μ s to 100 ms. Values exceeding these ranges will be rounded off.

Delay off when 0 is set.

[3] TRGPL trigger edge polarity

Sets the trigger detection polarity.

Command: TRGPL n

Query: TRGPL?

Response: TRGPL n

<Program data>

Value of n Set value

0 Positive (Initial value)

1 Negative

[4] TRM terminator
Selects the terminator when transmitting response data.
Program message: TRM n
<Program data>
Value of n Set value
0 LF (Initial value)
1 CRLF

[5] TRS transient mode
Enables (on) or disables (off) the high-speed sampling function.
Command: TRS n
Query: TRS?
Response: TRS n
<Program data>
Value of n Set value
0 Off (Initial value)
1 On

Note:

The high-speed sampling measurement can be started by executing *TRG or GET (address command).

[6] TRSOFS transient offset
Outputs the offset frequency fo that is used for calculating the input frequency during high-speed sampling measurement.
Refer to “[7] MTRS” in (9) M for the use method.
Query: TRSOFS?
Response: n

<Response data>
Value of n
Outputs in frequency units (HZ).
“0HZ” is returned when Input2 is selected.

[7] TRSSMP transient sample point
Sets the sample count to be measured, using the high-speed sampling function.
Command: TRSSMP n
Query: TRSSMP?
Response: TRSSMP n
<Program data>
Value of n
100, 200, 500, 1000, 2000 (Initial value: 2000)

- [8] TRSRT transient sample rate
Sets the sampling interval to store the high-speed sampling data.

Command: TRSRT n

Query: TRSRT?

Response: TRSRT n

<Program data>

Value of n

10×10^{-6} to 1000×10^{-6} (sec) (Initial value: 1000×10^{-6})

Suffix code: NS, US, MS, S, N, U, M

The setting resolution is 10 μ s.

5.4.5 Compatibility with MF76A Microwave Frequency Counter

Table 5.4.5-1 lists the GPIB commands for MF76A Microwave Frequency Counter (hereinafter, referred to as “MF76A”) and those for this unit, showing the compatibility between them.

The operation when an MF76A command in the left column is executed and the operation when a command for this unit is executed are equivalent.

Note that the MF76A commands keep the minimum necessary level of compatibility to be compatible with older models. Do not use these commands for new designs.

Table 5.4.5-1 Compatibility with MF76A GPIB Program Messages

MF76A GPIB Commands		GPIB Commands for This Unit			
Service request generation mode	RQ	RQ0	*SRE 0		
		RQ1	ESE2 1	*SRE 4	
		RQ2	*ESE 32	*SRE 32	
		RQ3	ESE2 1	*ESE 32	*SRE 36
		RQ4	*ESE 16	*SRE 32	
		RQ5	ESE2 1	*ESE 16	*SRE 36
		RQ6	*ESE 48	*SRE 32	
		RQ7	ESE2 1	*ESE 48	*SRE 36
Data terminator	DT	DT0	TRM 1		
		DT1	No corresponding command		
Measurement start command		RS	*TRG		
Initialization command		CL	*RST		
Switching of input range	IN	IN10	INPCH 2	INP2Z 0	
		IN11	INPCH 2	INP2Z 1	
		IN2	INPCH 1	INP2Z 0	
Switching of measurement resolution	RE	RE2	RES 2		
		RE3	RES 3		
		RE4	RES 4		
		RE5	RES 5		
		RE6	RES 6		
		RE7	RES 7		
		RE8	RES 8		
		RE9	RES 9		
		RE13	RES 0		
		RE14	RES 1		
		RE15	RES 2		
		RE16	RES 3		

Table 5.4.5-1 Compatibility with MF76A GPIB Program Messages (Cont'd)

MF76A GPIB Commands		GPIB Commands for This Unit		
Switching of sample rate	SR SR0 SR1 SR2	SH 0 SH 1 SH 0	SMP 0	
Selection of manual mode	MA MA0 MA10	ACF 0 ACF 1,1		
Selection of offset mode	OF OF0 OF10+ OF10- OF20+ OF20-	OFS 0 OFS 1,1 OFS 2,1 OFSDT 1 OFSDT 1	OFS 1 OFS 2	
Selection of parts per million mode	RA RA0 RA1	OFS 0 OFS 3		
Selection of burst mode	BU BU0 BU1	BST 0 BST 1		
Switching of amplitude discrimination	AD AD0 AD10	ACL 0 ACL 1,1		
Switching of output mode	OM OM0 OM1	OM 0 OM 1		

5.5 Setting and Checking GPIB

This section describes how to connect GPIB cables, set parameters, and check the cable connection and parameter settings required before using the GPIB.

5.5.1 Connecting GPIB cables

The GPIB interface connector is provided on the rear panel.

Up to fifteen devices, including the controller, can be connected to one GPIB system.

Connect the GPIB cables as shown in Figure 5.5.1-1.

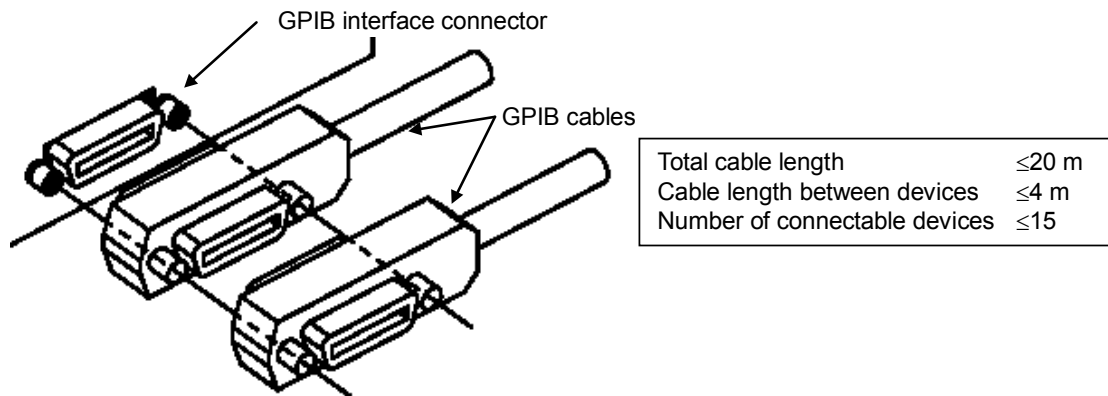

Figure 5.5.1-1 Conditions for GPIB Cable Connection

CAUTION

Make sure to connect the GPIB cables before turning on the unit.

5.5.2 Setting and checking GPIB address

The GPIB address cannot be set or checked externally. Set and check it through panel operation.

The following table shows the setting contents.

Table 5.5.2-1 GPIB Address Setting Range

Setting Item	Range	Factory Setting
GPIB address	0 to 30	8

Note:

The above setting contents are retained even after the unit is turned off.

5.5.3 Recommended GPIB board manufacturers

The recommended manufacturers of the GPIB board (GPIB card) used by the host computer are as follows.

Manufacturers: National Instruments Corporation.
Interface Corporation.

5.6 Sample Programs

This section provides sample programs for reference. These programs are provided assuming that an National Instruments GPIB board and NI-488.2™ software are used, and Visual Basic is used for control.

- (1) The following is a sample program that sets Input1, CW, Auto measurement, sample rate 1 s, and resolution 1 Hz, uses serial polling to wait for measurement to end, and reads and displays the measured frequency value.

- Sample program using Visual Basic

```

Sub SAMP1 ()
Dim ADRS(2) As Integer
ADRS(1) = 8                                'Sets GPIB address
ADRS(2) = -1
Cls
Call SendIFC(0)                            'Interface clear
If ibsta% And EERR Then
    Call ERRMSG(ADRS(1), "Error: IFC")
End If
Call EnableRemote(0, ADRS)                 'Remote enable
If ibsta% And EERR Then
    Call ERRMSG(ADRS(1), "Error: REN")
End If
Call DevClear(0, ADRS(1))                  'Device clear
If ibsta% And EERR Then
    Call ERRMSG(ADRS(1), "Error: DCL")
End If
Call Send(0, ADRS(1), "*RST;*CLS;TRM 1", NLEnd) 'Specifies preset, status clear, and terminator
If ibsta% And EERR Then
    Call ERRMSG(ADRS(1), "Error: SENDING COMMAND")
End If
Call Send(0, ADRS(1), "ESE2 1", NLEnd)     'Permits measurement end event status
Call Send(0, ADRS(1), "SMP 9;RES 3", NLEnd) 'Sets sample rate 1 s and resolution 1 Hz
Call Send(0, ADRS(1), "*CLS;*TRG", NLEnd)  'Sets status clear and trigger command
For I% = 1 To 10
    FREQ$ = Space$(20)
    Call Serpoll(ADRS(1))                   'Serial polling
    Call Send(0, ADRS(1), "MCW?", NLEnd)    'Reads measured frequency value
    Call Receive(0, ADRS(1), FREQ$, STOPend)
    Print FREQ$                             'Displays measured frequency value
Next I%

```

Call ibonl(ADRS(1), 0)

End Sub

Sub Serpoll (ADR%)

'Serial polling routine

Do

Call ReadStatusByte(0, ADR%, Status%)

If ibsta% And EERR Then

 Call ERRMSG(ADR%, "Error: could not read status byte.")

End If

Loop Until (Status% And &H4) = &H4

Call Send(0, ADR%, "*CLS", NLen)

End Sub

Sub ERRMSG (ADR% msg\$)

'Error message display routine

emsg\$ = "ADRS:" & ADR% & " " & msg\$

MsgBox emsg\$, vbCritical, "Error"

'Displays message on the screen

Call ibonl(ADR%, 0)

End

'End of program

End Sub

- (2) The following is a sample program that sets Input2, impedance 50 Ω , sample rate 10 ms, resolution 10 Hz, statistical processing Max, and hold mode, uses a service request to wait for measurement to end, and reads and displays the statistical processing value.

- Sample program using Visual Basic

```

Sub SAMP2 ()
Dim ADRS(2) As Integer
ADRS(1) = 8 'Sets GPIB address
ADRS(2) = -1
Cls
Call SendIFC(0) 'Interface clear
If ibsta% And EERR Then
    Call ERRMSG(ADRS(1), "Error: IFC") 'See sample program (1).
End If
Call EnableRemote(0, ADRS) 'Remote enable
If ibsta% And EERR Then
    Call ERRMSG(ADRS(1), "Error: REN")
End If
Call DevClear(0, ADRS(1)) 'Device clear
If ibsta% And EERR Then
    Call ERRMSG(ADRS(1), "Error: DCL")
End If
Call Send(0, ADRS%, "**RST;CLS;TRM 1", NLEnd) 'Specifies preset, status clear, and terminator
If ibsta% And EERR Then
    Call ERRMSG(ADRS(1), "Error: SENDING COMMAND")
End If
Call Send(0, ADRS(1), "ESE2 2;*SRE 4", NLEnd) 'Permits statistical processing end event status
'and END service request
Call Send(0, ADRS(1), "INPCH 2", NLEnd) 'Sets Input2 for input channel
Call Send(0, ADRS(1), "STS 2", NLEnd) 'Sets statistical processing Max
Call Send(0, ADRS(1), "SMP 3;RES 4;SH 1", NLEnd) 'Sets sample rate 10 ms, resolution 10 Hz, hold

For I% = 1 To 10
    FREQ$ = Space$(40)
    Call Send(0, ADRS(1), "**CLS;TRG", NLEnd) 'Sets status clear and trigger command
    Call Waisrq(ADRS(1))
    Call Send(0, ADRS(1), "MSTA?", NLEnd) 'Reads statistical processing value
    Call Receive(0, ADRS(1), FREQ$, STOPend)
    Print FREQ$
Next I%
Call ibonl(ADRS(1), 0)
End Sub

```

```
Sub Waisrq (ADR%)                                'SRQ routine
Do
  Call WaitSRQ(0, SRQasserted%)
  If SRQasserted% = 0 Then
    Call ERRMSG(ADR%, "Error: did not assert SRQ. ")
  End If
  Call ReadStatusByte(0, ADR%, Status%)
  If ibsta% And EERR Then
    Call ERRMSG(ADR%, "Error: could not read STB. ")
  End If
Loop Until (Status% And &H4) = &H4
Call Send(0, ADR%, "*CLS", NLEnd)
End Sub
```

- (3) The following is a sample program that sets Input1, burst mode, sample rate 100 ms, resolution 100 kHz, manual frequency 10 GHz, and hold mode, uses a service request to wait for measurement to end, and reads and displays the carrier frequency and pulse width values.

- Sample program using Visual Basic

```

Sub SAMP3 ()
Dim ADRS(2) As Integer
ADRS(1) = 8 'Sets GPIB address
ADRS(2) = -1
Cls
Call SendIFC(0) 'Interface clear
If ibsta% And EERR Then
    Call ERRMSG(ADRS(1), "Error: IFC") 'See sample program (1).
End If
Call EnableRemote(0, ADRS) 'Remote enable
If ibsta% And EERR Then
    Call ERRMSG(ADRS(1), "Error: REN")
End If
Call DevClear(0, ADRS(1)) 'Device clear
If ibsta% And EERR Then
    Call ERRMSG(ADRS(1), "Error: DCL")
End If
Call Send(0, ADRS(1), "**RST;*CLS;TRM 1", NLEnd) 'Specifies preset, status clear, and terminator
If ibsta% And EERR Then
    Call ERRMSG(ADRS(1), "Error: SENDING COMMAND")
End If
Call Send(0, ADRS(1), "ESE2 1;*SRE 4", NLEnd) 'Permits measurement end event status and
'END service request
Call Send(0, ADRS(1), "ACF 1;AF 1GHZ", NLEnd) 'Sets manual measurement, manual frequency
'1 GHz
Call Send(0, ADRS(1), "BST 1;BSTMD 1", NLEnd) 'Sets burst mode, burst width measurement
Call Send(0, ADRS(1), "SMP 6;RES 8;SH 1", NLEnd) 'Sets sample rate 100 ms, resolution 100 kHz

For I% = 1 To 10
    FREQ$ = Space$(20)
    WDT$ = Space$(20)
    Call Send(0, ADRS(1), "**CLS;*TRG", NLEnd) 'Sets status clear and trigger command
    Call Waisrq(ADRS(1)) 'See sample program (2).
    Call Send(0, ADRS(1), "MBCF?", NLEnd) 'Reads burst carrier frequency value
    Call Receive(0, ADRS(1), FREQ$, STOPend)
    Call Send(0, ADRS(1), "MBWDT?", NLEnd) 'Reads measured burst width value
    Call Receive(0, ADRS(1), WDT$, STOPend)
    Print FREQ$, WDT$ 'Displays measurement results.
Next I%
Call ibonl(ADRS(1), 0)
End Sub

```

- (4) The following is a sample program that sets Input2, impedance 1 M Ω , ATT On, sample rate 10 ms, resolution 1 Hz, and statistical processing Mean, and reads and outputs the measured value in the output mode 0 numeric value format.

- Sample program using Visual Basic

```

Sub SAMP4 ()
Dim ADRS(2) As Integer
ADRS(1) = 8                                'Sets GPIB address
ADRS(2) = -1
Cls
Call SendIFC(0)                            'Interface clear
If ibsta% And EERR Then
    Call ERRMSG(ADRS(1), "Error: IFC")      'See sample program (1).
End If
Call EnableRemote(0, ADRS)                 'Remote enable
if ibsta% And EERR Then
    Call ERRMSG(ADRS(1), "Error: REN")
End If
Call DevClear(0, ADRS(1))                  'Device clear
If ibsta% And EERR Then
    Call ERRMSG(ADRS(1), "Error: DCL")
End If
Call Send(0, ADRS(1), "*RST;TRM 1", NLEnd) 'Specifies preset, status clear, and terminator
If ibsta% And EERR Then
    Call ERRMSG(ADRS(1), "Error: SENDING COMMAND")
End If
Call Send(0, ADRS(1), "INPCH 2;INP2Z 1;ATTN 1", NLEnd) 'Sets input channel Input2, 1 M $\Omega$ , and ATT On
Call Send(0, ADRS(1), "SMP 3;RES 3;STS 1", NLEnd)    'Sets sample rate 10 ms, resolution 1 Hz, mean
Call Send(0, ADRS(1), "OM 0", NLEnd)                 'Specifies the output mode 0 numeric value
                                                        'format
For I% = 1 To 10
    FREQ$ = Space$(40)
    Call Receive(0, ADRS(1), FREQ$, STOPend)          'Read measured value
    Print FREQ$
Next I%
Call ibonl(ADRS(1), 0)
End Sub

```

- (5) The following is a sample program that sets Input1, manual frequency 1 GHz, amplitude discrimination L3, high-speed sample count 100, high-speed sampling period 100 μ s, external trigger, and trigger delay 100 μ s, enables the high-speed sampling function, uses service request to wait for measurement to end, reads the count value and converts it to frequency to obtain the frequency value.

- Sample program using Visual Basic

```

Sub SAMP5 ()
    Dim ADRS(2) As Integer
    ADRS(1) = 8                                'Sets GPIB address
    ADRS(2) = -1
    Static FREQ#(100)
    Cls
    Call SendIFC(0)                            'Interface clear
    If ibsta% And EERR Then
        Call ERRMSG(ADRS(1), "Error: IFC")     'See sample program (1).
    End If
    Call EnableRemote(0, ADRS)                 'Remote enable
    If ibsta% And EERR Then
        Call ERRMSG(ADRS(1), "Error: REN")
    End If
    Call DevClear(0, ADRS%)                    'Device clear
    If ibsta% And EERR Then
        Call ERRMSG(ADRS(1), "Error: DCL")
    End If
    Call Send(0, ADRS(1), "*RST;*CLS;TRM 1", NLEnd) 'Specifies preset, status clear, and terminator
    If ibsta% And EERR Then
        Call ERRMSG(ADRS(1), "Error: SENDING COMMAND")
    End If
    Call Send(0, ADRS(1), "ESE2 1;*SRE 4", NLEnd) 'Permits measurement end event status and
                                                    'END service request
    Call Send(0, ADRS(1), "ACF 1;AF 1GHZ;ACL 1;AD 3", NLEnd)
                                                    'Sets Manual measurement, 1 GHz, and L3
    Call Send(0, ADRS(1), "TRG 1;TRGDLY 100US", NLEnd) 'Sets external trigger and trigger delay 100  $\mu$ s
    Call Send(0, ADRS(1), "TRSSMP 100;TRSRT 100US;TRS 1", NLEnd)
                                                    'Sets sample count 100, sample period 100  $\mu$ s,
                                                    'and high-speed sampling function on
    Call Send(0, ADRS(1), "*CLS;*TRG", NLEnd)    'Sets status clear and trigger command
    Call Waisrq(ADRS(1))                        'See sample program (2).
    OFS$ = Space$(40)
    Call Send(0, ADRS(1), "TRSOFS?", NLEnd)     'Reads offset value
    Call Receive(0, ADRS(1), OFS$, STOPend)

```

```
FOFS# = Val(OFS$)
Call Send(0, ADRS(1), "MTRS? 100", NLEnd)
For I% = 0 To 99
    BUF$ = Space$(40)
    Call Receive(0, ADRS(1), BUF$, STOPend)
    SEP% = InStr(BUF$, ",")
    CNT1# = Mid(BUF$, 1, SEP% - 1)
    CNT2# = Mid(BUF$, SEP% + 1)
    If FOFS# >= 0 Then
        'Branches the processing according to
        'the offset value polarity (positive/negative)
        FREQ#(I%) = FOFS# + (CNT2# / CNT1#) * 1000000000
        'Processing when the offset value is positive
    Else
        FREQ#(I%) = FOFS# - (CNT2# / CNT1#) * 1000000000
        'Processing when the offset value is negative
    End If
    Print FREQ#(I%)
    'Displays the measured value
Next I%
Call Send(0, ADRS%, "TRS 0;RTM", NLEnd)
Call ibonl(ADRS(1), 0)
End Sub
```

- (6) The following is a sample program that sets Input2, impedance 1 M Ω , ATT On, sample rate 50 ms, resolution 1 kHz, and uses the data storage function to obtain the measured frequency value.

- Sample program using Visual Basic

```

Sub SAMP6 ()
Dim ADRS(2) As Integer
ADRS(1) = 8 'Sets GPIB address
ADRS(2) = -1
Cls
Call SendIFC(0) 'Interface clear
If ibsta% And EERR Then
    Call ERRMSG(ADRS(1), "Error: IFC") 'See sample program (1).
End If
Call EnableRemote(0, ADRS) 'Remote enable
If ibsta% And EERR Then
    Call ERRMSG(ADRS(1), "Error: REN")
End If
Call DevClear(0, ADRS(1)) 'Device clear
If ibsta% And EERR Then
    Call ERRMSG(ADRS%, "Error: DCL")
End If
Call Send(0, ADRS(1), "**RST;*CLS;TRM 1", NLEnd) 'Specifies preset, status clear, and terminator
If ibsta% And EERR Then
    Call ERRMSG(ADRS(1), "Error: SENDING COMMAND")
End If
Call Send(0, ADRS(1), "INPCH 2;INP2Z 1;ATTN 1", NLEnd) 'Sets Input2, impedance 1 M $\Omega$ , and ATT On
Call Send(0, ADRS(1), "SMP 5;RES 6", NLEnd) 'Sets sample rate 50 ms and resolution 1 kHz
Call Send(0, ADRS(1), "DSTA", NLEnd) 'Starts data storage
Call Send(0, ADRS(1), "**TRG", NLEnd) 'Sets trigger command
Call Send(0, ADRS(1), "**WAI", NLEnd) 'Waits until data storage is completed
Call Send(0, ADRS(1), "DSTP", NLEnd) 'Enables measured frequency value to be read
Call Send(0, ADRS(1), "MDS?", NLEnd) 'Reads measured frequency value
For I% = 1 To 100
    FREQ$ = Space$(20)
    Call Receive(0, ADRS(1), FREQ$, STOPend)
    Print FREQ$ 'Displays measured frequency value
Next I%
Call ibonl(ADRS(1), 0)
End Sub

```

Section 6 Operating Principles

This section describes the measurement principle, frequency measurement accuracy, pulse width measurement accuracy, and trigger error for this unit.

6.1	Configuration.....	6-2
6.2	Frequency Measurement.....	6-3
6.2.1	Measurement method for Input2/50 Ω system	6-3
6.2.2	Measurement method for Input2/1 M Ω system	6-5
6.2.3	Measurement method for Input1	6-6
6.3	Burst Width Measurement/ Burst Period Measurement.....	6-7
6.4	Trigger Error.....	6-8

6.1 Configuration

Figure 6.1-1 shows this unit's configuration.

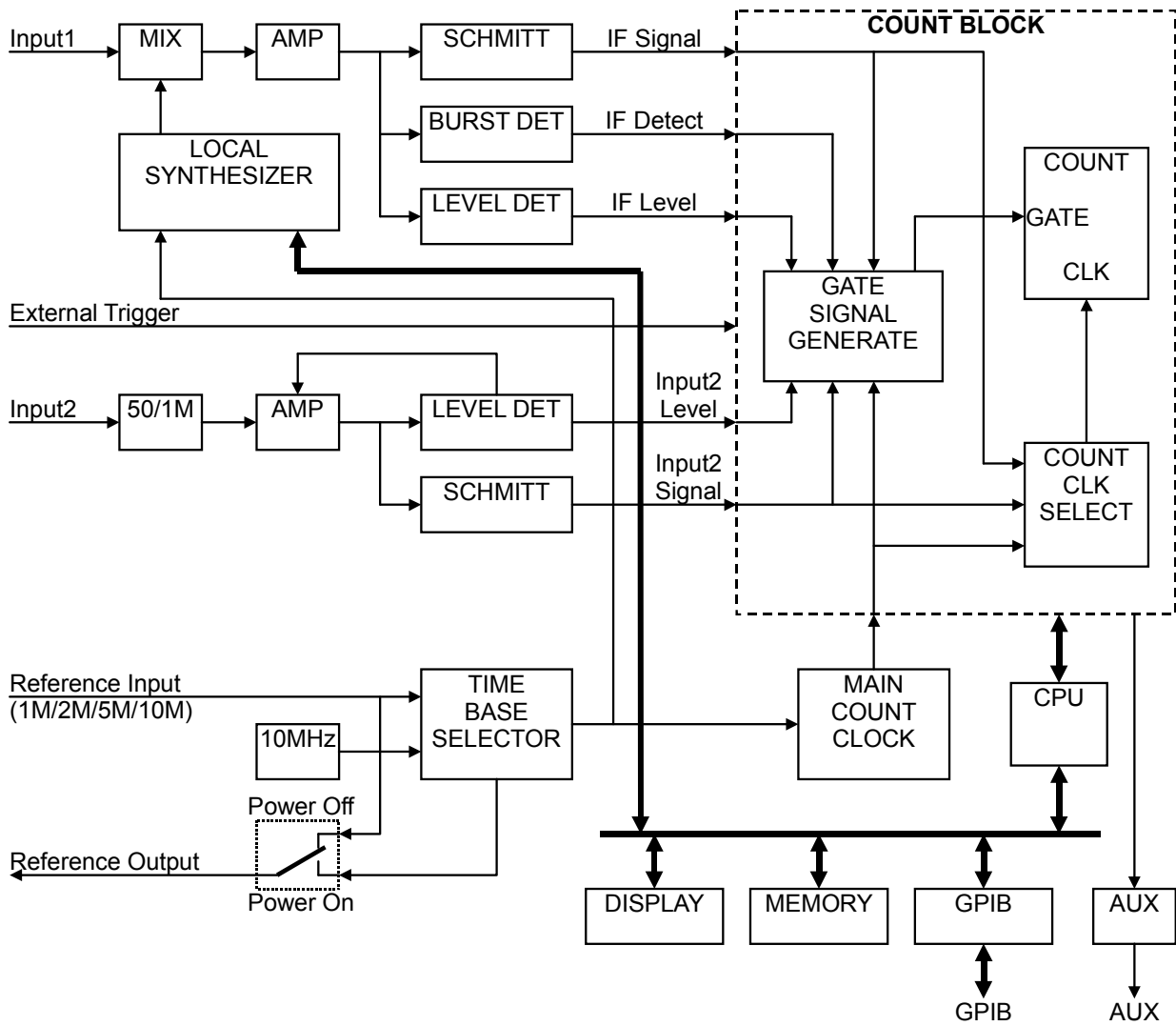

Figure 6.1-1 Block diagram

6.2 Frequency Measurement

Frequency means the number of vibrations per unit of time.

Direct counting, the most basic operating principle of frequency measurement, opens a gate between a precise unit of time created by a reference signal generation circuit, passes through the signal, counts it using a counting circuit, and then displays the result.

6.2.1 Measurement method for Input2/50 Ω system

The 50 Ω system (measurement frequency of 10 MHz to 1 GHz) input signal on Input2 of this unit is measured with the direct count method. Connected signal to the Input2 connector passes a 50 Ω /1 M Ω input impedance switch circuit and is added to the AMP and SCHMITT circuits. To prevent miscounts due to noise, the AMP amplitude is controlled so that the input level of the SCHMITT circuit remains constant regardless of the input level.

The SCHMITT circuit converts the waveform of the amplified signal to a pulse and then sends it to the counting circuit.

The counting circuit uses the reference signal generator signal as the standard, opens the gate only as long as the gate time of the count signal time (1 s at a resolution of 1 Hz and 1 ms at a resolution of 1 kHz) for obtaining the necessary resolution, and then counts the number of pulses. This pulse number is sent to the CPU which displays it as a measurement frequency.

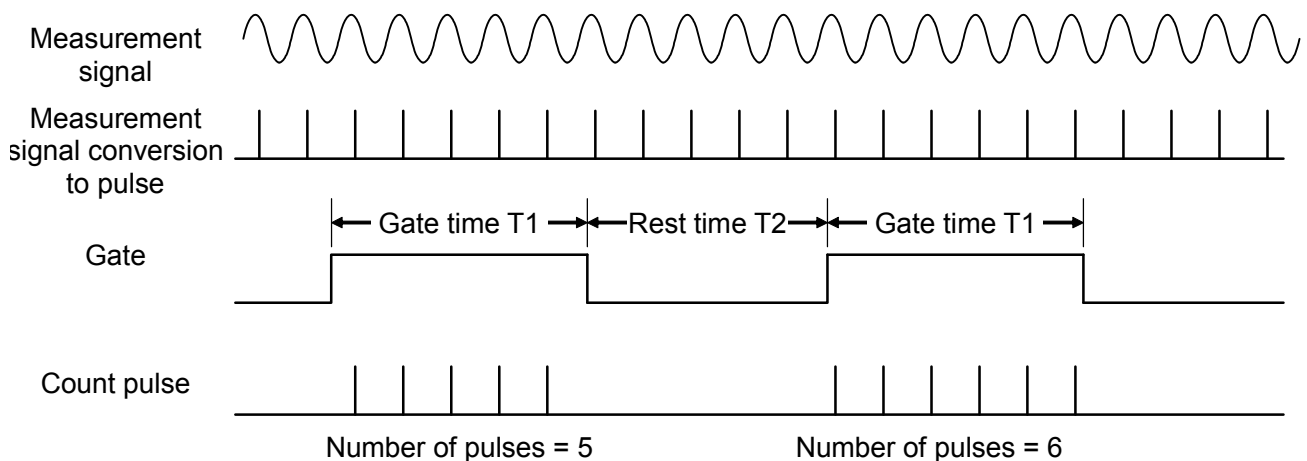

Figure 6.2.1-1 Direct counting

Section 6 Operating Principles

The pulse that is input has a ± 1 count error for the number of pulses because it is a signal not synchronized with the gate. This error is the ± 1 count item noted in the measurement error. Consequently, the final measurement accuracy is as follows:

$$\begin{aligned} \text{Measurement accuracy} &= \pm 1 \text{ count} \\ &\quad \pm \text{time base accuracy} \times \text{Measurement frequency} \end{aligned}$$

6.2.2 Measurement method for Input2/1 MΩ system

The 1 MΩ system (measurement frequency of 10 Hz to 10 MHz) input signal on Input2 of this unit is measured with the reciprocal method. The measurement signal, which was converted into a pulse waveform, is divided in the range from 1/2 to 1/10⁹ by the counting circuit. This division rate is decided by calculating the optimum value on the CPU from the correspondence between the necessary frequency resolution and the frequency of the measurement signal.

The counting circuit opens the gate for the amount of time required to divide the measurement signal by the division rate, measures the gate time, and then uses the CPU to calculate the frequency of the measurement signal from this gate time T (Internal reference clock frequency × Number of clocks “M”) and the division rate N.

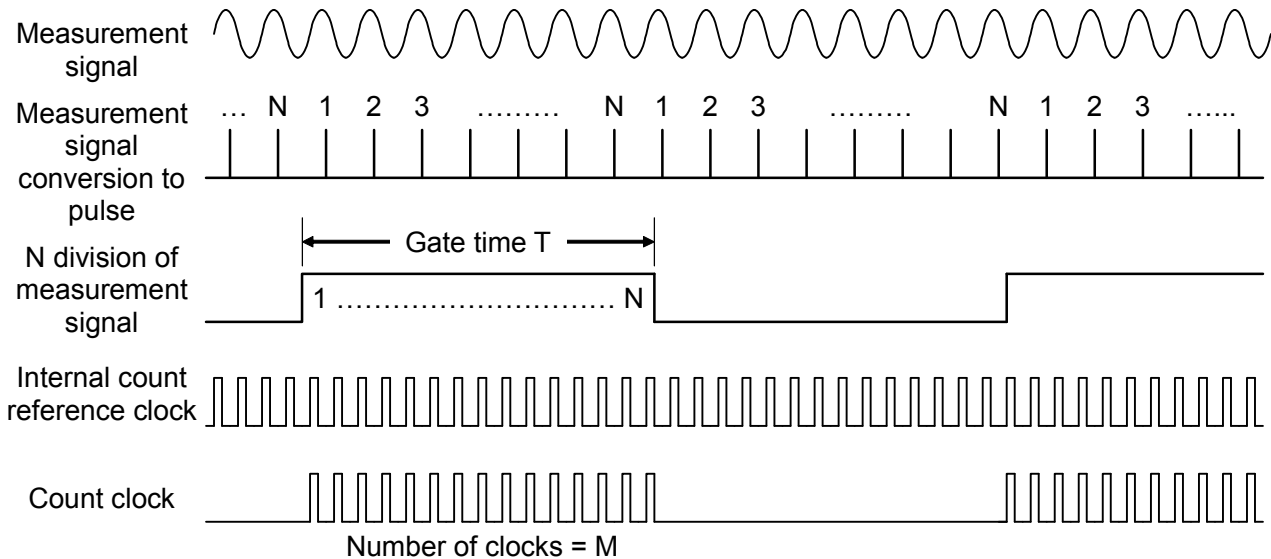

Figure 6.2.2-1 Reciprocal method

In the reciprocal method, the count error value will vary according to the noise level applied to the input signal because the gate time is determined by the input signal. This is added as trigger error noted by measurement error (Section 6.4 “Trigger Error” describes count error due to trigger error). The final measurement accuracy is as follows:

$$\begin{aligned} \text{Measurement accuracy} = & \pm 1 \text{ count} \\ & \pm \text{time base accuracy} \times \text{Measurement frequency} \\ & \pm \text{Trigger error} \end{aligned}$$

6.2.3 Measurement method for Input1

When measuring the input signal at the Input1 connector, the signal is first converted into an IF signal using the heterodyne down converter method. The count results using either the direct count method (when count mode is Normal) or the reciprocal method (when count mode is Fast) are then displayed.

Connecting the measurement signal to the Input1 connector mixes it with the local N harmonics in the harmonic mixer to obtain the IF signal.

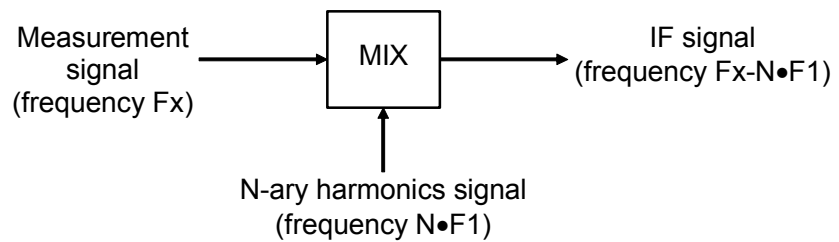

Figure 6.2.3-1 Heterodyne down converter method

The IF signal is amplified by the IF AMP, and then counted at the counter circuit.

If F_x is the frequency of the measurement signal, F_1 is the local frequency, and F_2 is the frequency of the IF signal counted, we get the following calculation:

$$F_x = N \cdot F_1 \pm F_2$$

When the count mode is Normal, measurement error is the same as the direct count method, and when it is Fast, it is the same as the reciprocal method. In addition, error due to harmonic mixing cannot be ignored on Input1. This error is called “residual stability”. The following shows whether to operate the measurement signal source and this unit at the same reference signal, and the accuracy when the unit uses a highly stable external reference signal:

<Count mode = Normal>

$$\begin{aligned} \text{Measurement accuracy} = & \pm 1 \text{ count} \\ & \pm \text{time base accuracy} \times \text{Measurement frequency} \\ & \pm \text{Residual error 1} * \end{aligned}$$

$$*: \text{Residual error 1} = \text{Measurement frequency (GHz)} / 10 \text{ counts (rms)}$$

<Count mode = Fast>

$$\begin{aligned} \text{Measurement accuracy} = & \pm 1 \text{ count} \\ & \pm \text{time base accuracy} \times \text{Measurement frequency} \\ & \pm \text{Trigger error} \pm \text{Residual error 2} * \end{aligned}$$

$$*: \text{Residual error 2} = \text{Measurement frequency (GHz)} / 2 \text{ counts (rms)}$$

6.3 Burst Width Measurement/Burst Period Measurement

The measurement signal input from Input1 is detected by the BURST DET circuit to generate a pulse signal. This pulse signal is taken as the gate time, and the number of clocks of the internal count clock is counted. This number of clocks is used to obtain the gate time by calculating on the CPU, and then displayed as the burst width.

For the burst period, the time from the start of a burst to the time of the start of the next burst (or the time from an end to the next end) is taken as the gate time, and the same operation takes place.

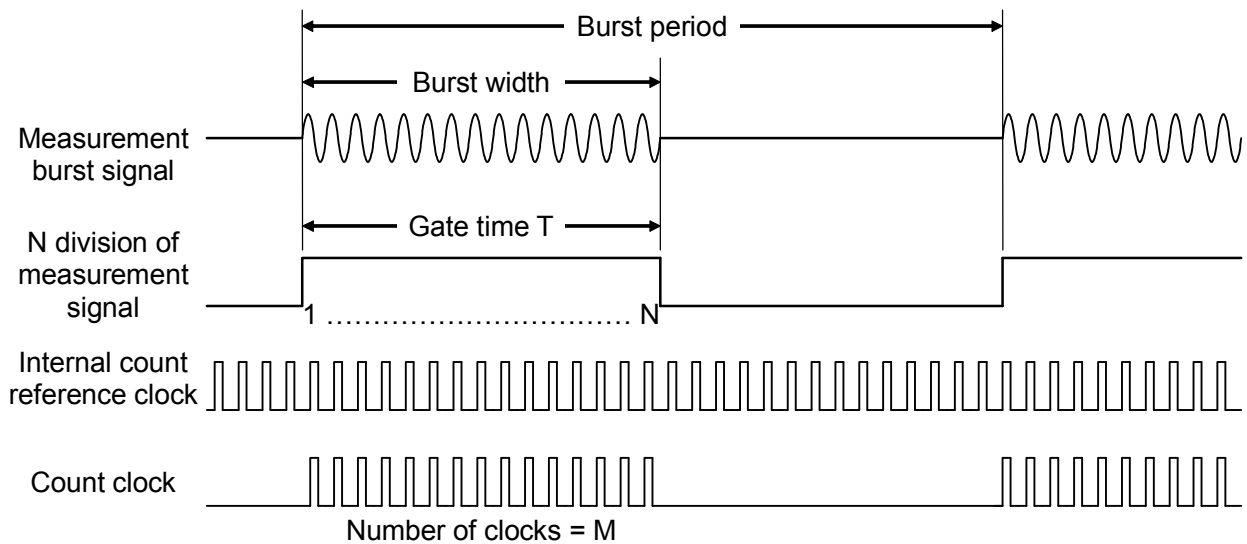

Figure 6.3-1 Burst width measurement

The gate is generated from the measurement signal, and the counting method using the counting circuit is the same as that for the reciprocal method. The error is also the same. Note that error due to detection is newly added for burst width and period measurement. This will be ± 20 ns when using this unit to measure a burst signal at an On/Off ratio of 40 dB and 0 cross (when On/Off is performed when the carrier signal phase is 0 degrees). Consequently, measurement accuracy is as follows:

$$\begin{aligned} \text{Measurement accuracy} = & \pm 20 \text{ ns} \\ & \pm \text{time base accuracy} \times \text{Measurement pulse width} \\ & \pm \text{Trigger error} \end{aligned}$$

Measurement burst signal : On/Off ratio of 40 dB, 0 cross

6.4 Trigger Error

When the count mode on Input1 is Fast and Input2 is the 1 M Ω system, this unit employs measurements using the reciprocal method that calculates and displays frequency by making calculations from period measured value.

When performing period measurements, it takes the measurement signal as the gate time unlike the frequency measurement, therefore the error will occur by minute noise components as fluctuation of the count time. As shown in Figure 6.4-1, when the gate opens/closes due to a noise signal at the trigger point, the gate time lengthens and shortens by ΔT . If S is the gradient (V/sec.) of the ideal signal in the trigger level and E_N is the peak value of the noise signal, the following relationship is established:

$$S = E_N/\Delta T$$

This means that the maximum measurement period deviation due to noise is $2\Delta T$, and if the measurement period is T , the trigger error is expressed by the ratio of $2\Delta T$ and the measurement period T as follows:

$$2\Delta T/T = 2 E_N (\text{peak value})/TS$$

For example, for a sine wave of period T and amplitude E_S , the gradient S of the trigger level is $2\pi E_S/T$, resulting in the following equation:

$$2\Delta T/T = E_N (\text{peak value})/\pi E_S (\text{amplitude})$$

As shown in Figure 6.4-1, an error of $2\Delta T$ occurs when there was trigger error for the ideal GATE. This is the counter error in the reciprocal frequency measurement described in Section 6.2 and burst width measurement/burst period measurement described in Section 6.3.

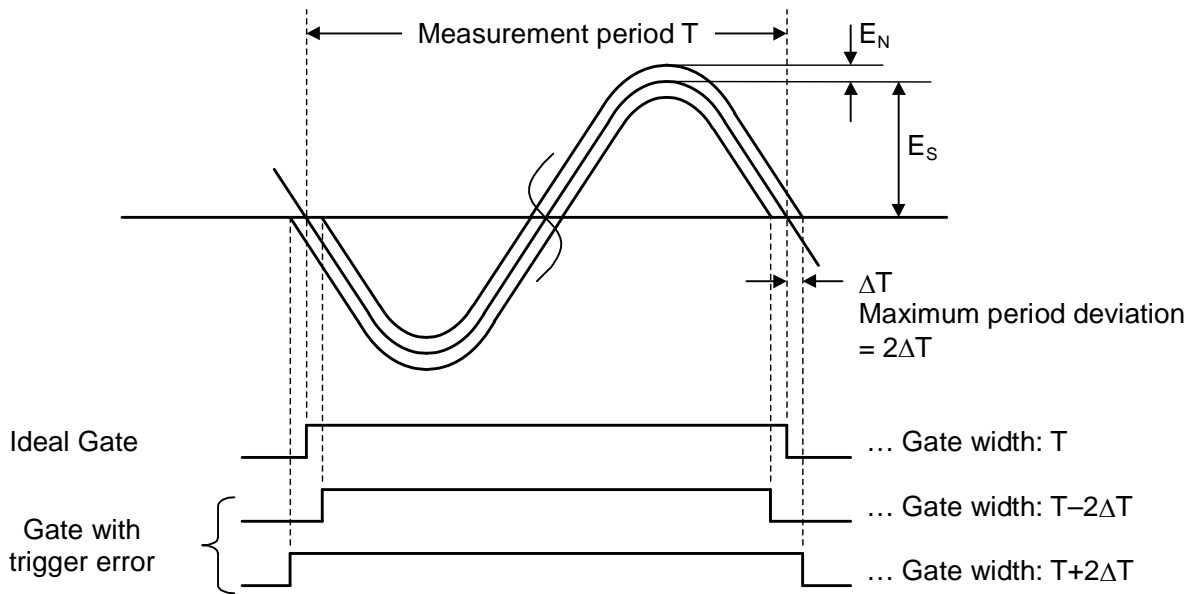

Figure 6.4-1 Trigger error due to noise

Figure 6.4-2 to 6.4-5 show the relationship between count error and input level, assuming that noise exists only in this unit (assumes there is no input signal noise).

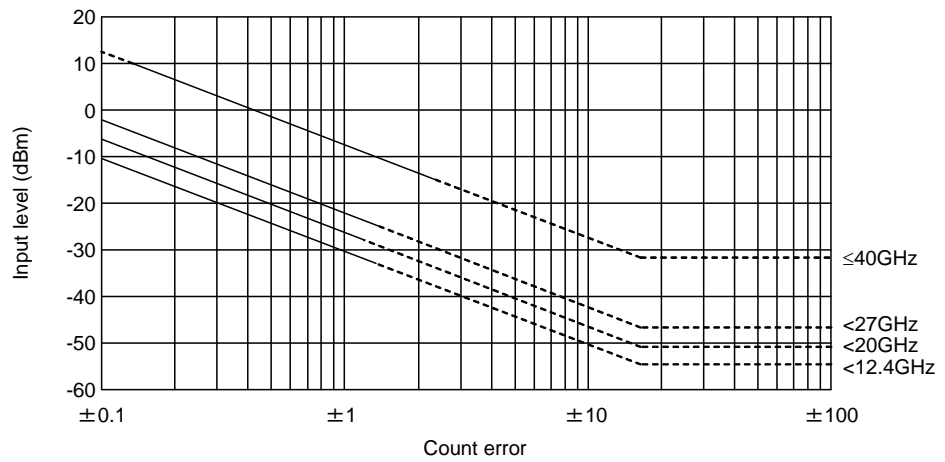

Figure 6.4-2 Count error vs. input level for Input1 frequency measurement

Section 6 Operating Principles

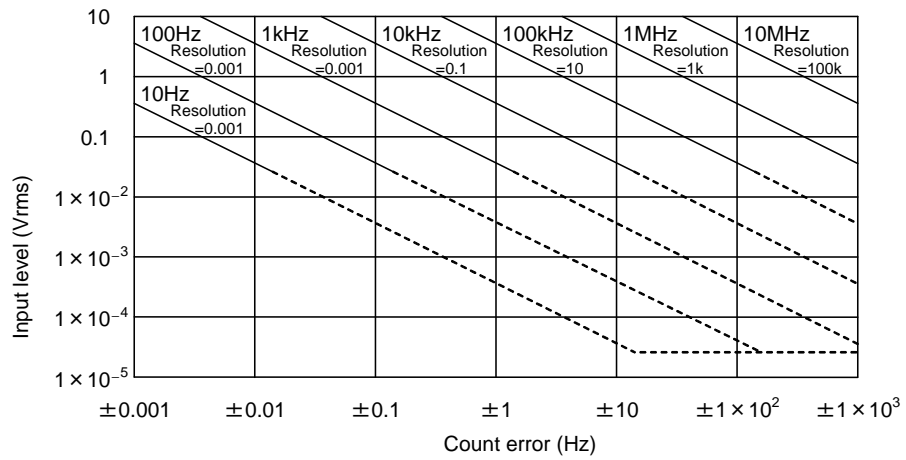

Figure 6.4-3 Count error vs. input level for Input2 frequency measurement

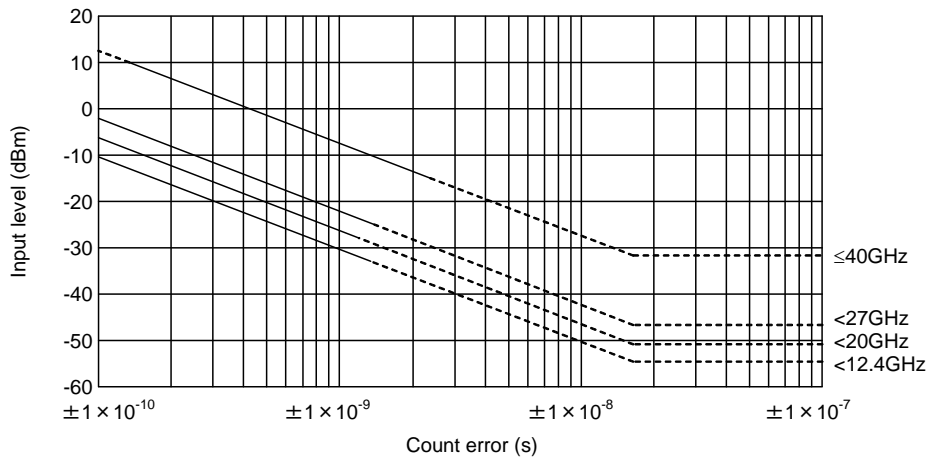

Figure 6.4-4 Count error vs. input level for Input1 pulse width measurement (Wide)

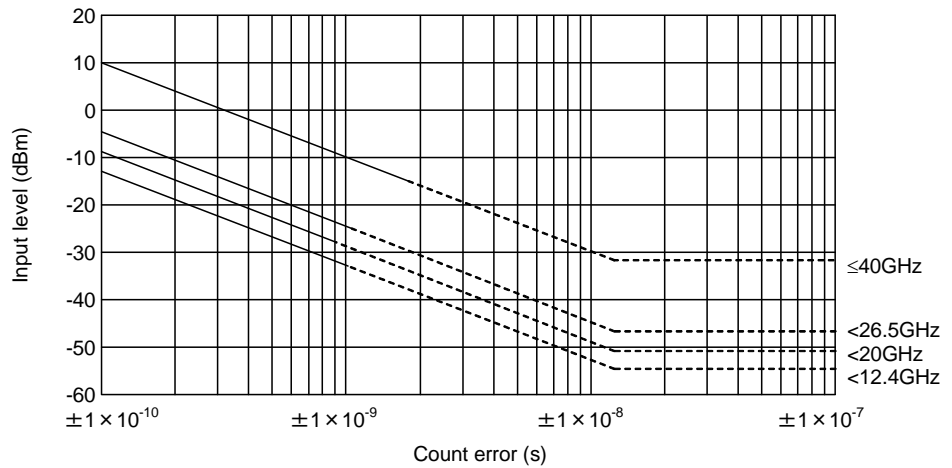

Figure 6.4-5 Count error vs. input level for Input1 pulse width measurement (Narrow)

Section 7 Performance Test

This section describes the measurement equipment, setup, and performance tests necessary for testing this unit performance.

7.1	When to Run Performance Tests	7-2
7.2	List of Performance Test Equipment	7-3
7.3	Performance Test	7-4
	7.3.1 Continuous frequency measurement	7-4
	7.3.2 Burst wave carrier frequency measurement .	7-7
	7.3.3 Burst width measurement.....	7-8

7.1 When to Run Performance Tests

The purpose of performance tests is preventative maintenance in order to detect and head off degraded performance before it occurs. The performance tests that are required include a test after purchase, routine test, and performance test after repairs.

The following items are tested during each of the tests described above.

- Continuous frequency measurement
- Burst wave carrier frequency measurement
- Burst width measurement

Periodically carry out performance tests for preventative maintenance. The minimum recommended number of tests is one or two a year.

Contact our service department if a performance test discovers that the unit is not performing according to its specifications.

7.2 List of Performance Test Equipment

Table 7.2-1 shows the equipment for performance tests.

Table 7.2-1 List of Performance Test Equipment

Test Item	Test Equipment (Recommended Anritsu Model No.)	Required Performance ^{*1}
7.3.1.1 Continuous frequency measurement (Input1)	Power meter (ML2437A/ML2438A) 10 MHz to 50 GHz	Frequency range 10 MHz to 20 GHz: MF2412C 10 MHz to 27 GHz: MF2413C 10 MHz to 40 GHz: MF2414C
	Power sensor (MA2473D) 10 MHz to 32 GHz, -70 to +20 dBm (MA2474D)	
7.3.1.2 Continuous frequency measurement (Input2, 50 Ω)	10 MHz to 40 GHz, -70 to +20 dBm	Sensitivity -33 to 0 dBm
	Fixed attenuator ^{*2} (MP721D) 20 dB	
7.3.2 Burst wave carrier frequency measurement	Signal generator (MG3692B) Up to 20 GHz (MG3693B) Up to 30 GHz (MG3694B) Up to 40 GHz	Frequency range 10 MHz to 20 GHz: MF2412C 10 MHz to 27 GHz: MF2413C 10 MHz to 40 GHz: MF2414C Output level -33 to 0 dBm Pulse modulation width 100 ns Pulse modulation accuracy ±10 ns or less
7.3.3 Burst width measurement	Power meter	Frequency range 10 Hz to 10 MHz Sensitivity 25 mVrms
	Power sensor	
7.3.1.3 Continuous frequency measurement (Input2, 1 MΩ)	Signal generator	Frequency range 10 Hz to 10 MHz Output level 25 mVrms

*1: Some of the performance items that can cover performance measurement tests have been excluded.

*2: Used when testing at -33 dBm.

7.3 Performance Test

When performing the performance tests, warm up the unit to be tested and the measuring equipment (refer to Section 4.1.1 for warm-up time of this unit) and wait for it to stabilize before proceeding with testing.

To achieve maximum measurement sensitivity, you must also perform tests at room temperature and make sure there is little fluctuation in the AC power supply and that there is not a harmful amount of noise, vibration, dust, or humidity.

7.3.1 Continuous frequency measurement

7.3.1.1 Continuous frequency measurement on Input1

(1) Test specifications

- Frequency range
 - 600 MHz to 20 GHz (MF2412C)
 - 600 MHz to 27 GHz (MF2413C)
 - 600 MHz to 40 GHz (MF2414C)
- Input sensitivity
 - 33 dBm: <12.4 GHz
 - 28 dBm: <20.0 GHz
 - 25 dBm: <27.0 GHz
 - $\{0.741 \times f \text{ (GHz)} - 44.6\}$ dBm: ≤ 40.0 GHz
- Measurement accuracy
 - Count mode Normal (direct count) :
 - $\pm 1 \text{ count} \pm \text{time base accuracy} \times \text{Measurement frequency}$
 - $\pm \text{Residual error 1}$
 - Note: Residual error 1
 - $= \{\text{Measurement frequency (GHz)} / 10 \text{ counts (rms)}\}$
 - Count mode Fast (reciprocal):
 - $\pm 1 \text{ count} \pm \text{time base accuracy} \times \text{Measurement frequency}$
 - $\pm \text{Residual error 2} \pm \text{Trigger error}$
 - Note: Residual error 2
 - $= \{\text{Measurement frequency (GHz)} / 2 \text{ counts (rms)}\}$

(2) Test equipment

- Signal generator
- Power meter
- Power sensor

- (3) Test procedure
 - 1) Set the unit to preset values. To perform a test in Normal mode, switch the count mode setting.
 - 2) Connect the Reference Output connector on the rear panel of the unit and the external reference input connector on the signal generator.
 - 3) Use a measurement cable to connect the signal generator output connector to the power meter input connector.
 - 4) Adjust the signal generator output level so that the read value on the power meter is adjusted to the rated sensitivity.
 - 5) Disconnect the measurement cable from the power meter input connector, and connect it to Input1 connector of the unit.
 - 6) Check that the output frequency of the signal generator is being displayed on the counter.
 - 7) Change the output frequency of the signal generator, repeat steps 3) to 6), and check that frequency is properly displayed within the specified range.

7.3.1.2 Continuous frequency measurement on Input2 (50 Ω : 10 MHz to 1 GHz)

- (1) Test specifications
 - Frequency range
10 MHz to 1 GHz
 - Input sensitivity
25 mVrms
 - Measurement accuracy
 $\pm 1 \text{ count} \pm \text{time base accuracy} \times \text{Measurement frequency}$
- (2) Test equipment
 - Signal generator
 - Power meter
 - Power sensor
- (3) Test procedure
 - 1) Set the unit to preset values.
 - 2) Set the input channel to Input2.
 - 3) Connect the Reference Output connector on the rear panel and the external reference input connector on the signal generator.
 - 4) Use a measurement cable to connect the signal generator output connector to the power meter input connector.

- 5) Adjust the signal generator output level so that the read value on the power meter is adjusted to the rated sensitivity.
- 6) Disconnect the measurement cable from the power meter input connector, and connect it to Input2 connector of the unit.
- 7) Check that the output frequency of the signal generator is being displayed on the counter.
- 8) Change the output frequency of the signal generator, repeat steps 4) to 7), and check that frequency is properly displayed within the specified range.

7.3.1.3 Continuous frequency measurement on Input2 (1 M Ω : 10 Hz to 10 MHz)

- (1) Test specifications
 - Frequency range
10 Hz to 10 MHz
 - Input sensitivity
25 mVrms
 - Measurement accuracy
 ± 1 count \pm Trigger error
- (2) Test equipment
 - Signal generator
 - Power meter
 - Power sensor
- (3) Test procedure
 - 1) Set the unit to preset values.
 - 2) Set the input channel to Input2, impedance to 1 M Ω and ATT to Off.
 - 3) Connect the Reference Output connector on the rear panel and the external reference input connector on the signal generator.
 - 4) Use a measurement cable to connect the signal generator output connector to the power meter input connector.
 - 5) Adjust the signal generator output level to the rated sensitivity of the power meter.
 - 6) Disconnect the measurement cable from the power meter input connector, and connect it to Input2 connector of the unit.
 - 7) Check that the output frequency of the signal generator is being displayed on the counter.
 - 8) Change the output frequency of the signal generator, repeat steps 4) to 7), and check that frequency is properly displayed within the specified range.

7.3.2 Burst wave carrier frequency measurement

(1) Test specifications

- Frequency range
 - 600 MHz to 20 GHz (MF2412C)
 - 600 MHz to 27 GHz (MF2413C)
 - 600 MHz to 40 GHz (MF2414C)
- Input sensitivity
 - 33 dBm: <12.4 GHz
 - 28 dBm: <20.0 GHz
 - 25 dBm: <27.0 GHz
 - $\{0.741 \times f \text{ (GHz)} - 44.6\}$ dBm: ≤ 40.0 GHz
- Pulse width
 - 100 ns (Burst width: Narrow)
- Measurement accuracy
 - $\pm 1 \text{ count} \pm \text{time base accuracy} \times \text{Measurement frequency}$
 - $\pm \text{Residual error 2} \pm \text{Trigger error} \pm 1/T_{GW}$
 - Note: Residual error 2
 - $= \{\text{Measurement frequency (GHz)}/2 \text{ counts (rms)}\}$,
 - $T_{GW} = \text{Gate width}$

(2) Test equipment

- Signal generator capable of pulse modulation or a signal generator and pulse modulator
- Power meter
- Power sensor

(3) Test procedure

- 1) Set the unit to preset values.
- 2) Make the following settings:
 - Burst width: Narrow
 - Measurement resolution: 1 MHz
 - Frequency acquisition mode: Manual
 - Manual frequency: Output frequency of signal generator
- 3) Connect the Reference Output connector on the rear panel and the external reference input connector on the signal generator.
- 4) Set signal generator output to continuous wave (pulse modulation Off), and then use a measurement cable to connect the signal generator output connector to the power meter input connector.
- 5) Adjust the signal generator output level so that the read value on the power meter is adjusted to the rated sensitivity.

- 6) Disconnect the measurement cable from the power meter input connector, and connect it to Input1 connector of this unit.
- 7) Check that the output frequency of the signal generator is being displayed on the counter.
- 8) Set the pulse modulation width to 100 ns, repetition period to 50 ns, and turn pulse modulation On.
- 9) Set the unit's Meas Mode to Burst.
- 10) Check that the output frequency of the signal generator is being displayed on the counter.
- 11) Change the output frequency of the signal generator, repeat steps 4) to 10), and check that frequency is properly displayed.

7.3.3 Burst width measurement

(1) Test specifications

- Pulse width
 - 100 ns to 100 ms (Burst width: Narrow)
 - * Manual frequency: 1 GHz or more
 - 1 μ s to 100 ms (Burst width: Wide)
- Input sensitivity
 - 33 dBm: <12.4 GHz
 - 28 dBm: <20.0 GHz
 - 25 dBm: < 27.0 GHz
 - $\{0.741 \times f \text{ (GHz)} - 44.6\}$ dBm: ≤ 40.0 GHz
- Measurement accuracy
 - ± 20 ns \pm time base accuracy \times Measurement pulse width
 - \pm Trigger error

(2) Test equipment

- Signal generator capable of pulse modulation or a signal generator and pulse modulator
- Power meter
- Power sensor

(3) Test procedure

- 1) Set the unit to preset values.
- 2) Make the following settings:

Burst width:	Narrow
Burst mode:	Width
Measurement resolution:	1 MHz
Frequency acquisition mode:	Manual
Manual frequency:	Output frequency of signal generator
- 3) Set the pulse modulation width to 100 ns and repetition period to period to pulse modulation width + 1 μ s.
- 4) Connect the Reference Output connector on the rear panel and the external reference input connector on the signal generator.
- 5) Set signal generator output to continuous wave (pulse modulation Off), and then use a measurement cable to connect the signal generator output connector to the power meter input connector.
- 6) Adjust the signal generator output level so that the read value on the power meter is adjusted to the rated sensitivity.
- 7) Disconnect the measurement cable from the power meter input connector, and connect it to Input1 connector of this unit.
- 8) Check that the output frequency of the signal generator is being displayed on the counter.
- 9) Turn pulse modulation On.
- 10) Set the unit's Meas Mode to Burst.
- 11) Check that the burst width measurement value displays the pulse modulation width.
- 12) Change the output frequency of the signal generator, repeat steps 5) to 11), and check that the burst width measurement value is properly displayed.

Note :

The pass-fail decision standard varies depending on the pulse modulation accuracy of the signal generator used for performance tests. For example, when the pulse modulation accuracy is ± 10 ns, the precision ratio against the unit's burst width measurement accuracy, ± 20 ns, is 2.0. In this case, the tolerance coefficient (guard band coefficient) is 0.935, which means that the pass-fail decision standard is as follows:

$$(\pm 20 \text{ ns} \pm \text{time base accuracy} \times \text{Measurement pulse width} \pm \text{Trigger error}) \times 0.935$$

Table 7.3.3-1 shows the main precision ratios and tolerance coefficients.

Table 7.3.3-1 Main Precision Ratios and Tolerance Coefficients

Precision Ratio	Tolerance Coefficient
4.0	1.00
3.5	0.990
3.0	0.975
2.5	0.960
2.0	0.935
1.5	0.895
1.0	0.825

Section 8 Storing and Transporting

This section describes daily maintenance for this unit and how to store, repackage, and transport it.

8.1	Cleaning the Cabinet	8-2
8.2	Notes on Storage	8-3
	8.2.1 Before storing	8-3
	8.2.2 Recommended storage conditions	8-3
8.3	Repackaging and Transporting	8-4
	8.3.1 Repackaging	8-4
	8.3.2 Transporting	8-4
8.4	Final Disposal	8-4

8.1 Cleaning the Cabinet

Make sure to turn power off and unplug the unit before cleaning it.

Clean the outside cabinet of the unit as follows:

- Wipe it with a soft, dry cloth.
- When the unit is dirty, you have been using it in an area with a lot of dust, or it has been stored away for a long period of time, apply a diluted mild cleaner to a soft cloth and use it to wipe the unit clean. Immediately wipe the unit dry with a soft, dry cloth.
- If you notice any of the screws or other parts are loose, use the proper tools to tighten them.



CAUTION

Make sure to turn power off and unplug the unit before cleaning it.

Do not use benzene, thinner, alcohol, or other strong chemicals to clean the cabinet. Failing to obey this warning may damage or discolor it.

8.2 Notes on Storage

This section provides information for storing the unit for extended periods of time.

8.2.1 Before storing

- (1) Wipe away any dust, finger prints, or stains from the unit.
- (2) Avoid storing in the following locations:
 - Areas exposed to direct sunlight or large amounts of dust.
 - Areas with high humidity where condensation may occur.
 - Areas exposed to volatile gases or areas where the unit might oxidize.
 - Areas with the following temperature and humidity:
Temperature: $\geq 70^{\circ}\text{C}$, $\leq -30^{\circ}\text{C}$
Humidity: $\geq 80\%$

8.2.2 Recommended storage conditions

In addition to the above mentioned conditions, make sure to observe the following environment conditions when storing the unit for a long period of time.

- Temperature: 0 to 30°C
- Humidity: 40 to 70%
- Place with little daily temperature and humidity variation

8.3 Repackaging and Transporting

Note the following information when sending this unit to Anritsu for repairs.

8.3.1 Repackaging

Use the packaging materials and box the unit originally came with. If they are not available, use the following materials:

- (1) Wrap the unit in plastic or similar material.
- (2) Obtain a cardboard or aluminum box large enough to hold material for absorbing physical shock from all sides.
- (3) Fill the box on all sides with material for absorbing physical shock so that the unit will not move within the box.
- (4) To prevent the box from opening during transportation, seal the box shut tightly with plastic bands, adhesive tape, or other suitable means.

8.3.2 Transporting

Transport by avoiding vibrations as much as possible and fulfilling the conditions recommended above.

8.4 Final Disposal

Follow the instructions of your local waste disposal office when disposing of the MF2412C/MF2413C/ MF2414C.

Appendix A List of Initial Values and Preset Values

The following is a list of initial values and preset values for this unit.

Group	Parameter	Initial Value/Preset Value
Measurement mode	Measurement mode	CW/CW
Resolution	Resolution	100 Hz/100 Hz
Sample rate	Sample rate	100 ms/100 ms
Input	Input connector	Input1/Input1
	Input2 impedance Input2•1 MΩ system 20 dBmATT	50 Ω/50 Ω On/On
Frequency	Frequency acquisition	Auto/Auto
	Manual frequency value	Fmax*/Fmax*
	Count method	Fast/Fast
Level	Level acquisition	Auto/Auto
	Manual amplitude discrimination value	L0/L0
Burst	Burst mode	Freq/Freq
	Burst measurement polarity	Pos/Pos
	Burst width	Wide/Wide
Trigger	Trigger mode	Int/Int
	Trigger polarity	Rise/Rise
	Trigger delay value	Off/Off
Gate	Gate width value	100 ms/100 ms
	Gate end	Off/Off
Template	Template	Off/Off
	Upper frequency limit value	Fmax*/Fmax*
	Lower frequency limit value	0 Hz/0 Hz
	Movement direction indicator	Off/Off
Offset	Offset	Off/Off
	Offset value	0 Hz/0 Hz
	Update mode	Off/Off
Statistical processing	Statistical processing	Off/Off
	Extraction mode	Disc/Disc
	Sample count	1/1
High-speed sampling	High-speed sampling	Off/Off
	Sampling period	1 ms/1 ms
	Sampling times	2000/2000
Memory	Save	All clear/(unavailable)
Reference signal selection	Reference signal selection	Auto/Auto
GPIB	Address	8/(unavailable)
AUX	AUX	Off/Off
Intensity	Intensity	75%/(unavailable)

* : Fmax = 20 GHz (for MF2412C)
27 GHz (for MF2413C)
40 GHz (for MF2414C)

Appendix B Performance Test Result Sheet

Test location: _____ Report No.: _____

_____ Date : _____

_____ Tester: _____

Model name: MF2412C/MF2413C/MF2414C Microwave Frequency Counter

Model No. _____ Ambient temperature: _____ %

Power frequency: _____ Hz Relative humidity: _____ °C

Notes:

Equipment used for performance testing

Power meter: _____

Power sensor: _____

Signal generator: _____

Others: _____

Performance test name: CW frequency measurement (Input1) Note: _____

Measurement Frequency	600 MHz	1 GHz	10 GHz	20 GHz	27 GHz	30 GHz	40 GHz	
Measurement Uncertainty								

Performance test name: CW frequency measurement (Input2) Note: _____

Measurement Frequency	10 Hz	100 Hz	1 MHz	10 MHz	100 MHz	500 MHz	1 GHz	
Measurement Uncertainty								

Performance test name: Burst wave carrier measurement Note: _____

Measurement Frequency	600 MHz	1 GHz	10 GHz	20 GHz	27 GHz	30 GHz	40 GHz	
Measurement Uncertainty								

Performance test name: Burst width measurement Note: _____

Measurement Frequency	100 ns	1 μs	10 μs	100 μs	1 ms	10 ms	100 ms	
Measurement Uncertainty								

Symbol

-  and  keys 3.1.1, 3.2.3
-  and  keys 3.1.1, 3.2.3

A

- AC power inlet 3.1.2
- Attenuator 4.3.1
- ATTon display 4.2.1
- Auto display 4.2.1
- AUX output connector 3.1.2

B

- Block diagram 6.1
- Burst** key 3.1.1
- Burst measurement mode 4.3.7, 4.4
- Burst monitor screen 4.2.2, 4.3.8, 4.4.8
- Burst pulse width and the maximum frequency resolution 4.3.3
- Burst repetition period 4.3.7, 4.4
- Burst width 4.3.7, 4.4

C

- Cleaning 8.1
- CNF 4.2.1, 4.3.12
- Compatibility with MF76 5.4.5

D

- Data storage function 4.3.17, 5.2, 5.4.4
- Device message 5.2, 5.4
- Device message list 5.4.4
- Direct count method 4.3.6, 6.2.1, 6.2.3
- Direct key 3.1.1, 3.2, 4.2.2
- Discrete mode 4.3.11

E

- Earth terminal 2.3.2, 3.1.2
- Enter** key 3.1.1
- External Trigger Input 2.2.5, 3.1.2
- External trigger 4.3.9
- External trigger input connector 2.2.5, 3.1.2

F

- Fan 2.1, 3.1.2
- Final Disposal 8.4
- Freq** key 3.1.1
- Frequency Acquisition LED 3.1.1
- Frequency acquisition 4.3.6, 4.4
- Frequency resolution 3.1.1, 4.3.3
- Fuse holder 2.3.3, 3.1.2
- Fuse replacement 2.3.3

G

- Gate 4.2.1
- Gate end 4.3.8, 4.3.9
- Gate width 4.3.8, 4.4.8
- Gating 4.3.8, 4.4.8
- Go 4.2.1, 4.3.12
- GPIB address 4.3.15, 5.5.2
- GPIB board 5.5.3
- GPIB cable connection 5.5.1
- GPIB interface connector 3.1.2
- GPIB interface function 5.3
- GW** key 3.1.1
- Guard band coefficient 7.9

H

- Heterodyne down converter method 6.2.3
- High-speed sampling function 4.3.16
- Hold 3.1.1, 4.3.13
- Hold** key 3.1.1
- Hold LED 3.1.1

I

- IEEE488.2 common command 5.4.2
- Indicator display 4.3.12
- Input impedance 4.3.1
- Input** key 3.1.1
- Input1 LED 3.1.1
- Input1 input connector 2.2.2, 3.1.1

Index

Input2 LED 3.1.1
Input2 input connector 2.2.3, 3.1.1
Internal trigger 4.3.9

L

L0 to L7 4.2.1
LCD 3.1.1
Level acquisition 4.3.5, 4.4
Level display 4.2.1
Level key 3.1.1
Line trigger 4.3.9
List of initial values and preset values
Appendix A
Local key 3.1.1
LOF 4.2.1, 4.3.12

M

Manual amplitude discrimination value
4.3.5, 4.4
Manual frequency value 4.3.6, 4.4
Meas Mode key 3.1.1
Meas Mode LED 3.1.1
Measurement mode 4.3.4
Measurement screen 4.2, 4.2.1
Menu screen 4.2.2
Moving direction indicator 4.2.1, 4.3.12

N

No-Go 4.2.1, 4.3.12
Normal measurement screen
4.2.1
Numeric keypad 3.1.1, 3.2.3, 4.2.2

O

Offset 4.3.10
Ofs key 3.1.1
On LED 3.1.1
Operating principle Section 6
Option 1.3.2, 1.4.2
Optional accessory 1.3.3
Overlap mode 4.3.11

P

Performance test result sheet
Appendix B
Power line switch 2.3.3, 3.1.2
Preset key 3.1.1

R

Recall 4.3.15
Reciprocal method 4.3.6, 6.2.2, 6.2.3, 6.3
Reference Input 2.2.4, 3.1.2
Reference signal input connector
2.2.4, 3.1.2
Reference signal output connector
3.1.2
Remote LED 3.1.1
Repacking 8.3.1
Residual error 1 1.4.1, 6.2.3, 7.3.1
Residual error 2 1.4.1, 6.2.3, 7.3.1,
7.3.2
Resolution key 3.2.3
Restart 3.1.1, 4.3.14
Restart key 3.1.1
Return to Meas key 3.1.1

S

Safety measures 2.2
Sample Rate key 3.2.3
Sample program 5.6
Sample rate 3.2.3, 4.3.2
Save 4.3.15
Self check 4.1.2, 4.2.3, 4.3.15
Setup LED 3.1.1
Setup screen 4.2, 4.2.2
Specifications for Option 003
1.4.2
Standard composition 1.3.1
Standard specifications 1.4.1
Stat key 3.1.1
Statistical processing function
4.3.11
Stby LED 3.1.1
Suffix code 5.4.1, 5.4.5

Switching input 4.3.1
Sys key 3.1.1
System 4.3.15
System screen 4.2.3

T

TD key 3.1.1
Temp key 3.1.1
Template function 4.3.12
Template screen 4.2.1, 4.3.12
Trig delay 4.3.8, 4.4.8
Transporting 8.3.2
Trig key 3.1.1
Trigger and gate end 4.3.9
Trigger delay 4.3.8, 4.4.8
Trigger error 1.4.1, 6.2, 6.3, 6.4

U

UNCAL 4.2.1, 4.3.3, 4.4
UPF 4.2.1, 4.3.12

